

# **SINGER**

**201K1 thru 4**

# ILLUSTRATED LIST OF PARTS

FOR

## CLASS 201K MACHINES

FOR FAMILY USE

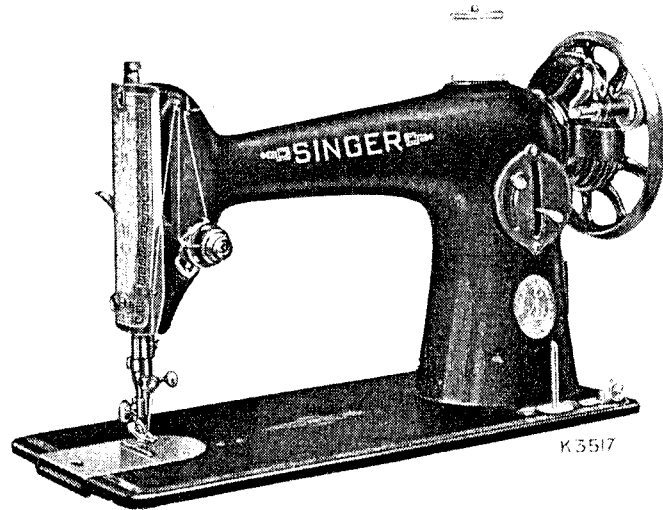

\*\* A Trade Mark of  
THE SINGER MANUFACTURING CO.

121170

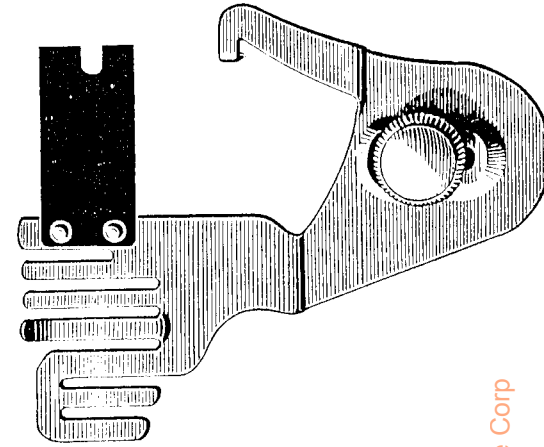

121547

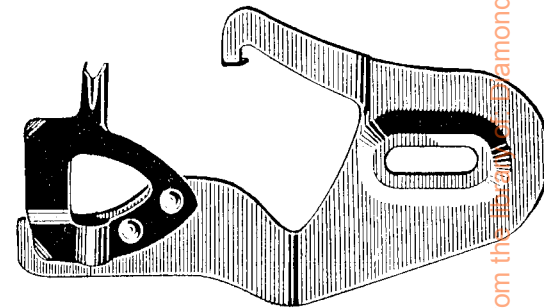

From the ~~Illustration~~ of Diamond Needle Corp

15282

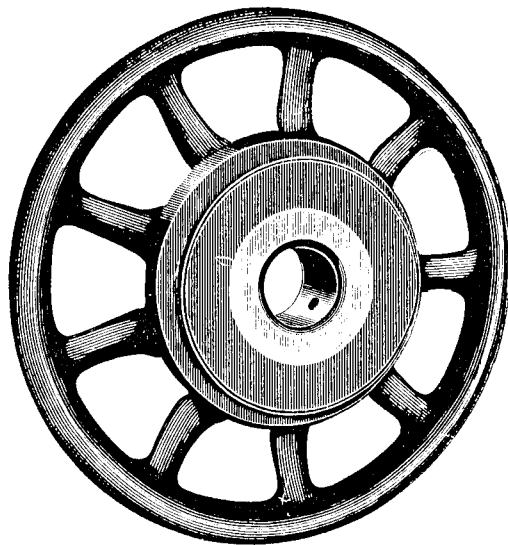

87589

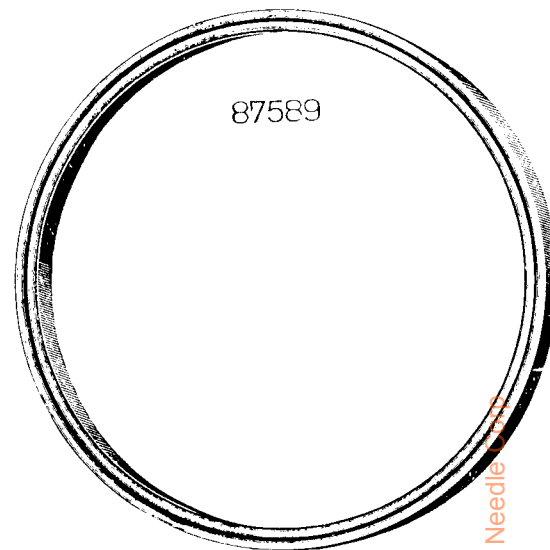

96422

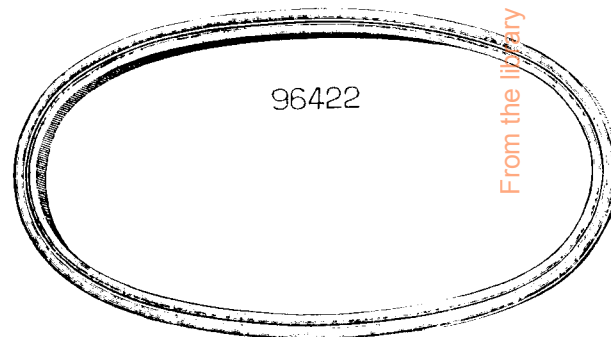

From the library of: Diamond Needle Co.

32672

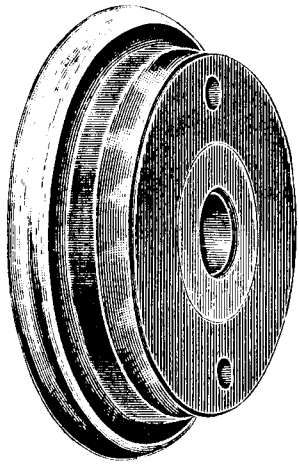

120687

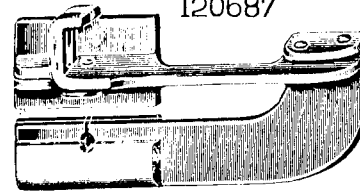

85893



36583

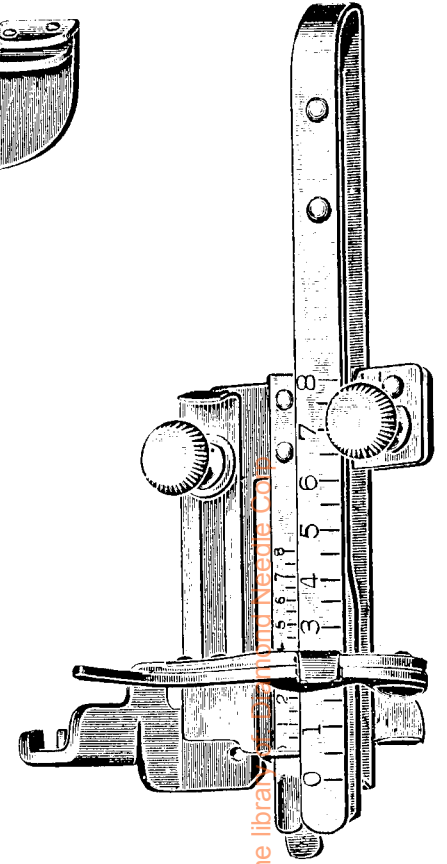

45213

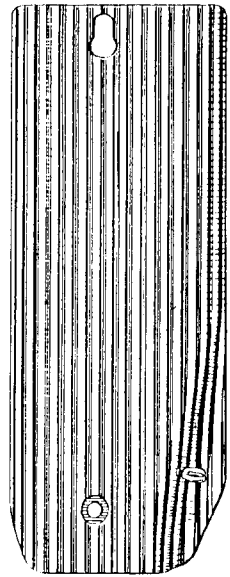

45242 8366



45215

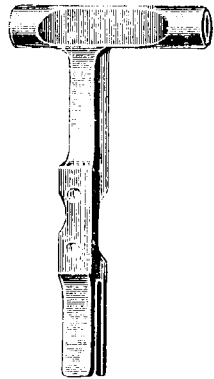

45229

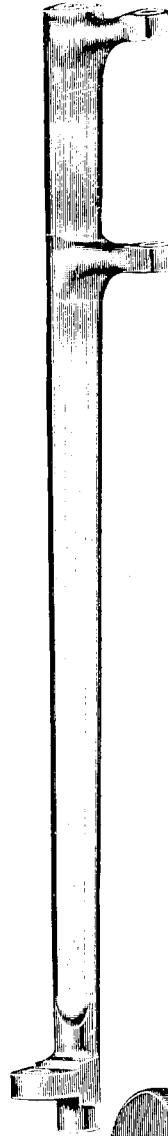

45223



45217

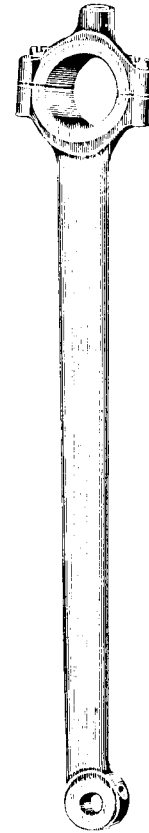

45222

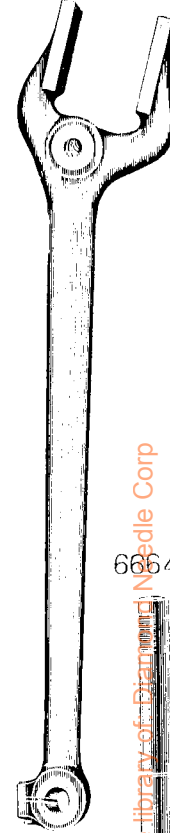

45299



45246

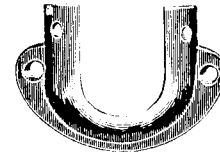

45244

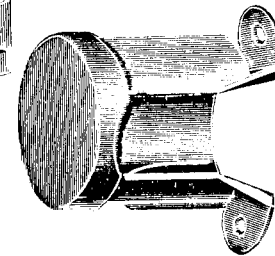

45251

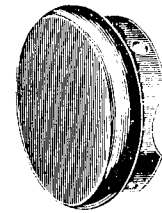

68643

From the library of Diamond Needle Corp

45323 45249



45356

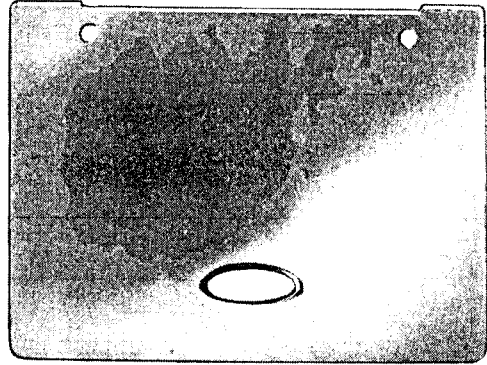

66581



45357

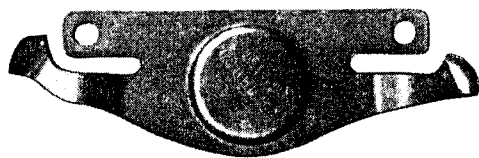

45237



45219

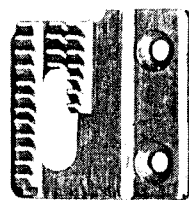

45232

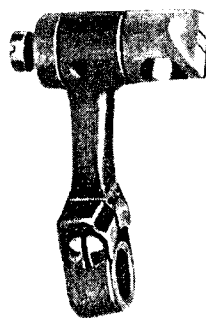

45343

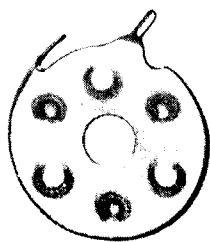

66774

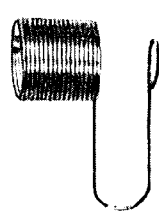

45214

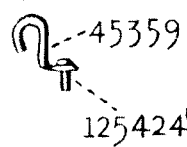

125424

45221



45347

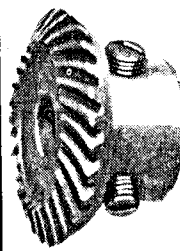

45852

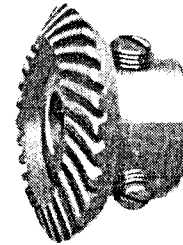

45349



45348

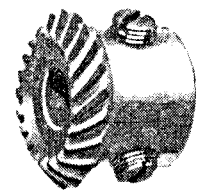

45346

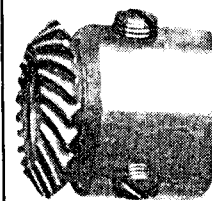

45853

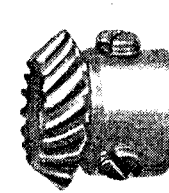

45220

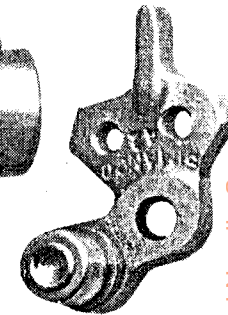

45209

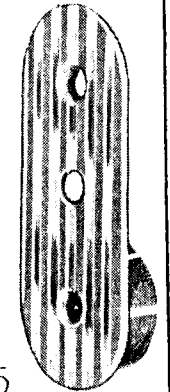

45261

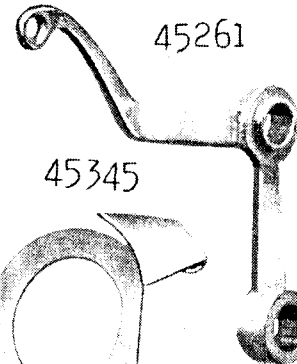

66593

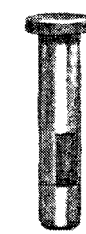

45225



45345

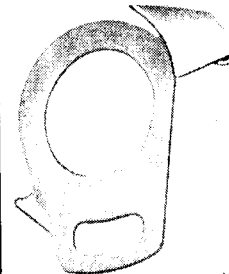

45354



45264



45265

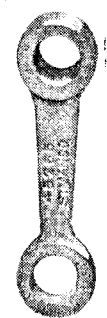

45335

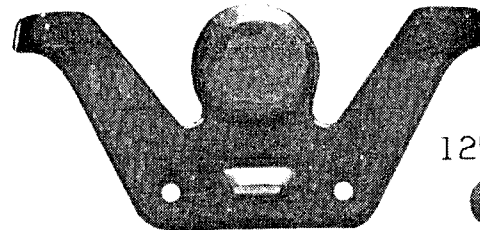

45355



125400 51282



From the library of: Diamond Needle Corp

45270

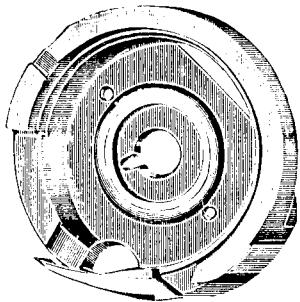

45273

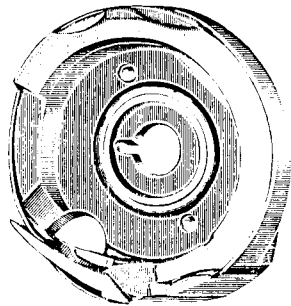

45276

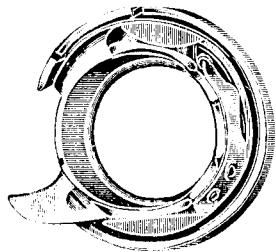

45278

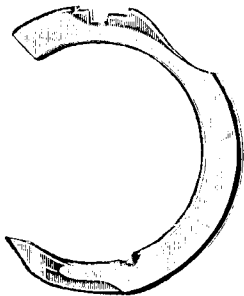

45277



32519



239



45279



707



50463



1353



50150



51302



45293



1172



1173



45281



45292

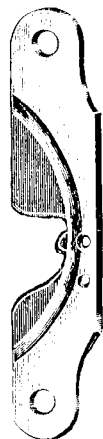

45280



51306



45282



1259



45207

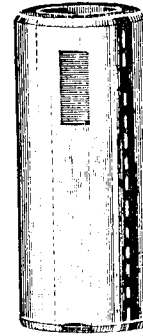

45208

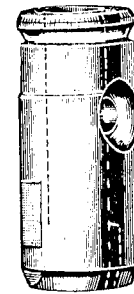

45247



45252

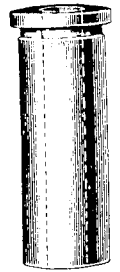

45325

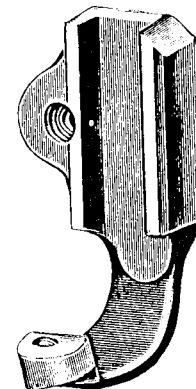

45234

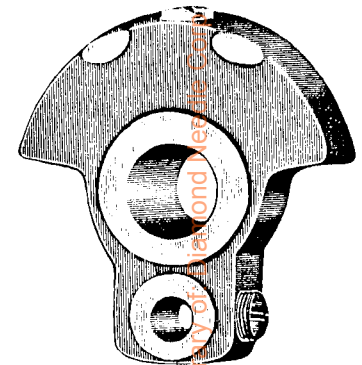

45311

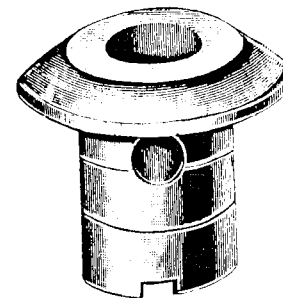

45322

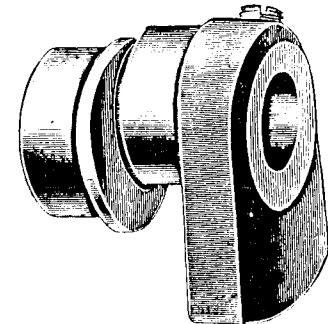

From the library of the National Archives and Records Administration

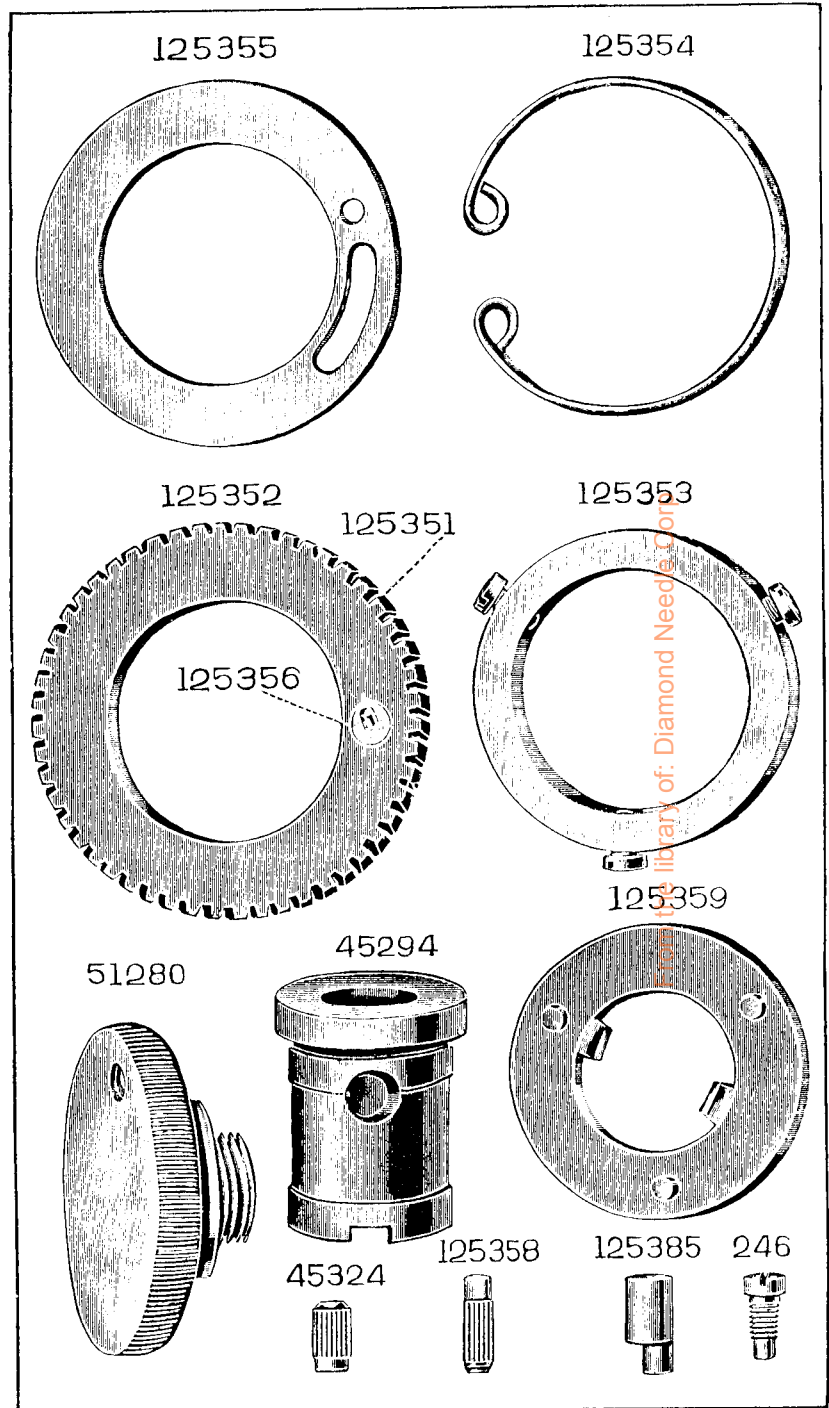
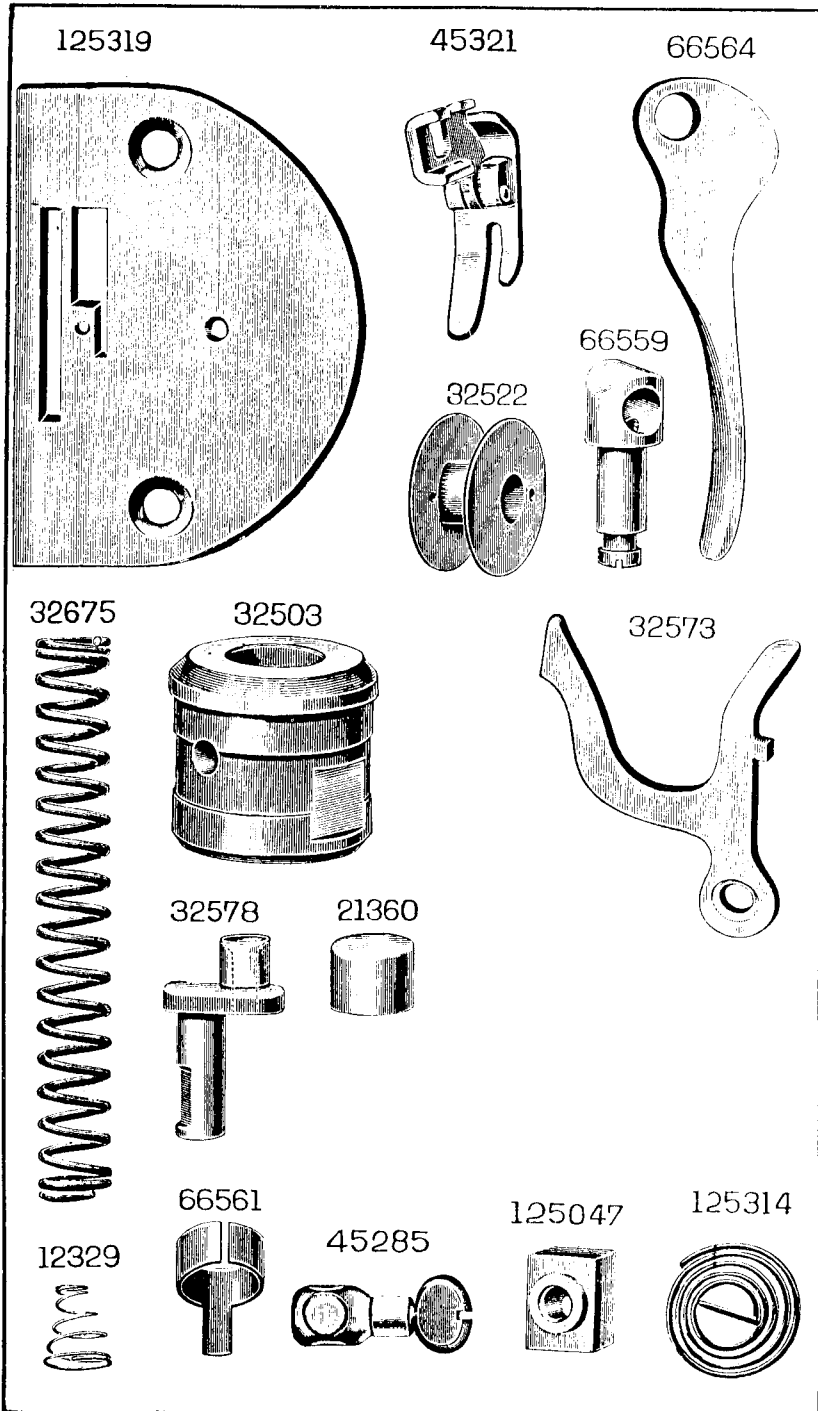



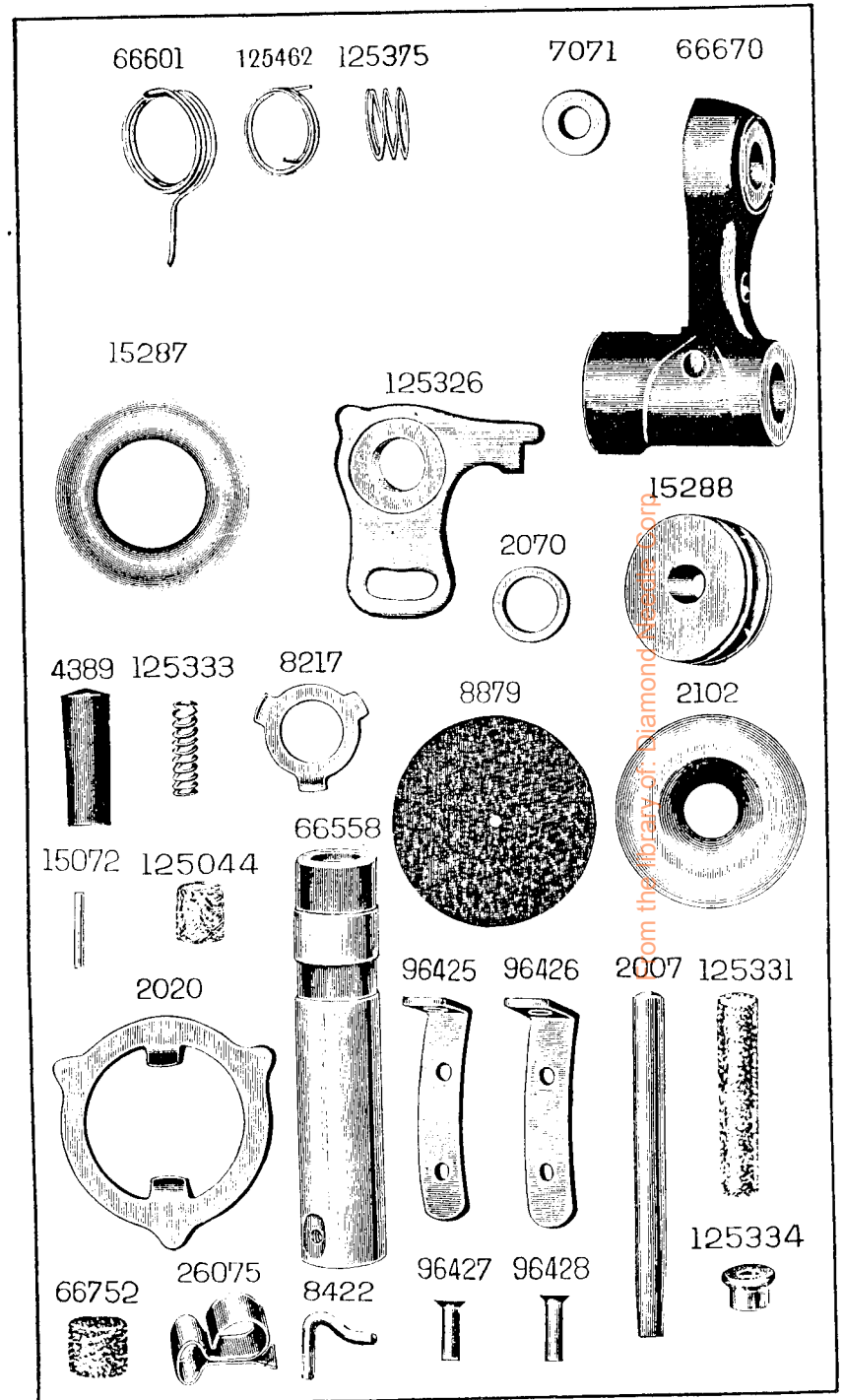
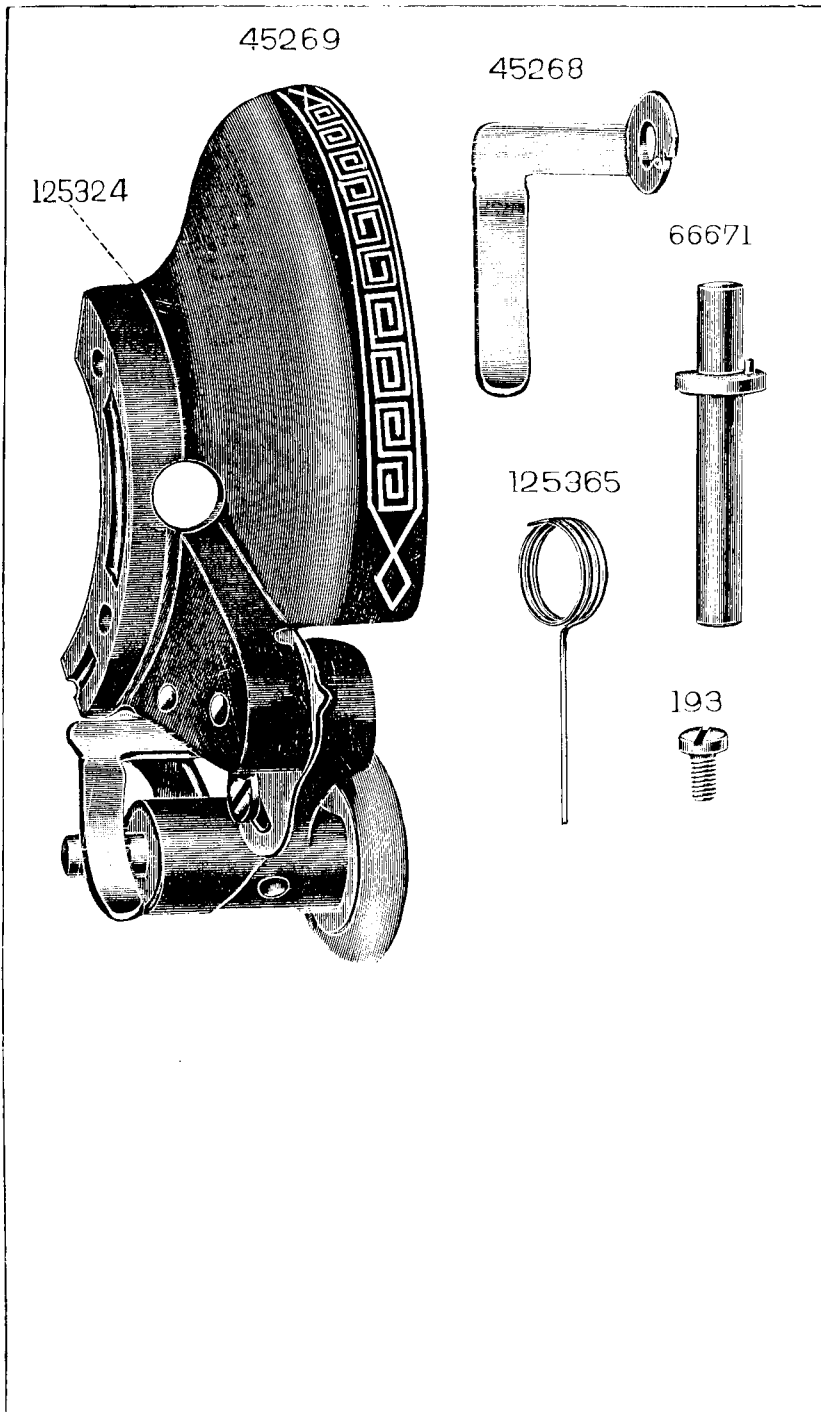

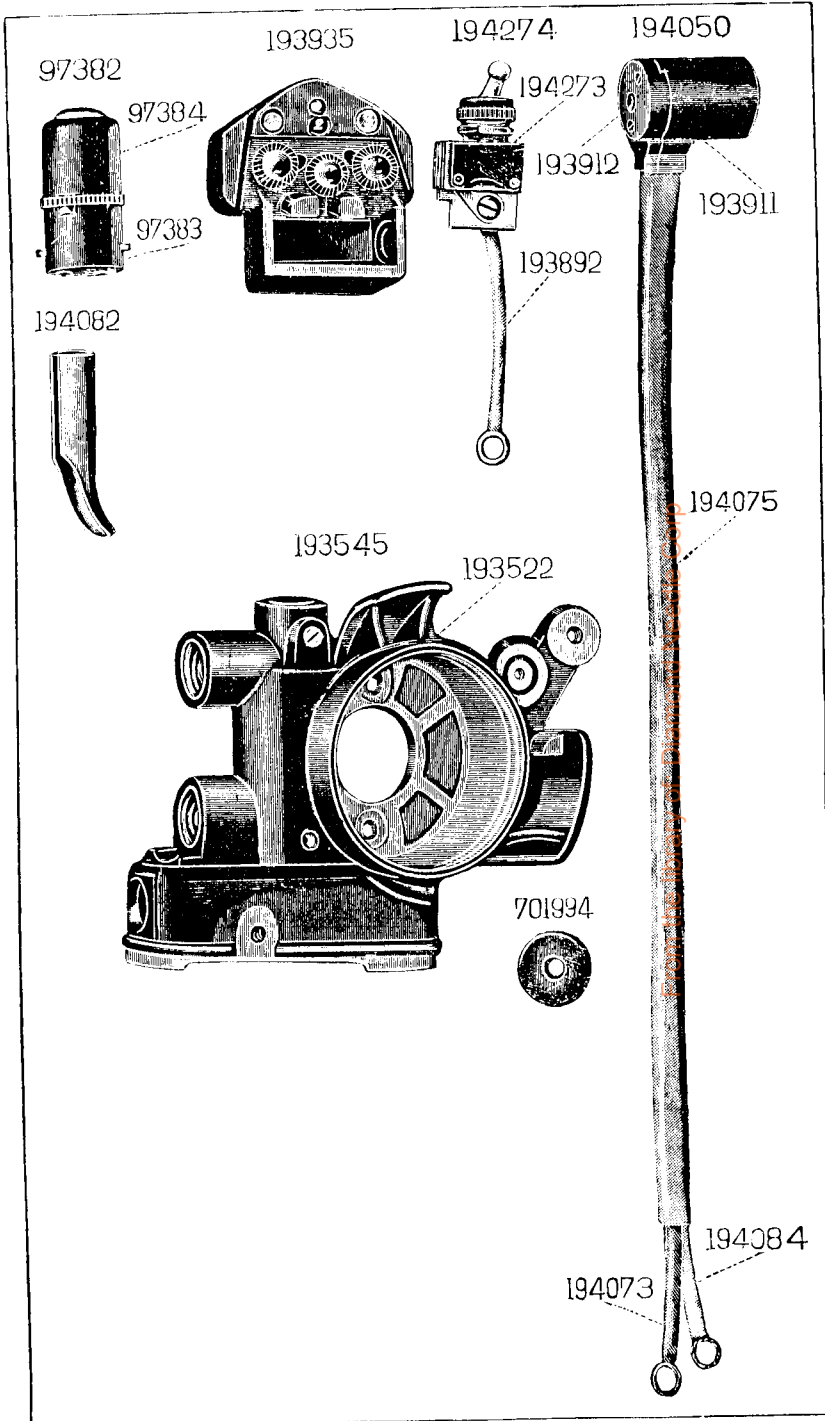
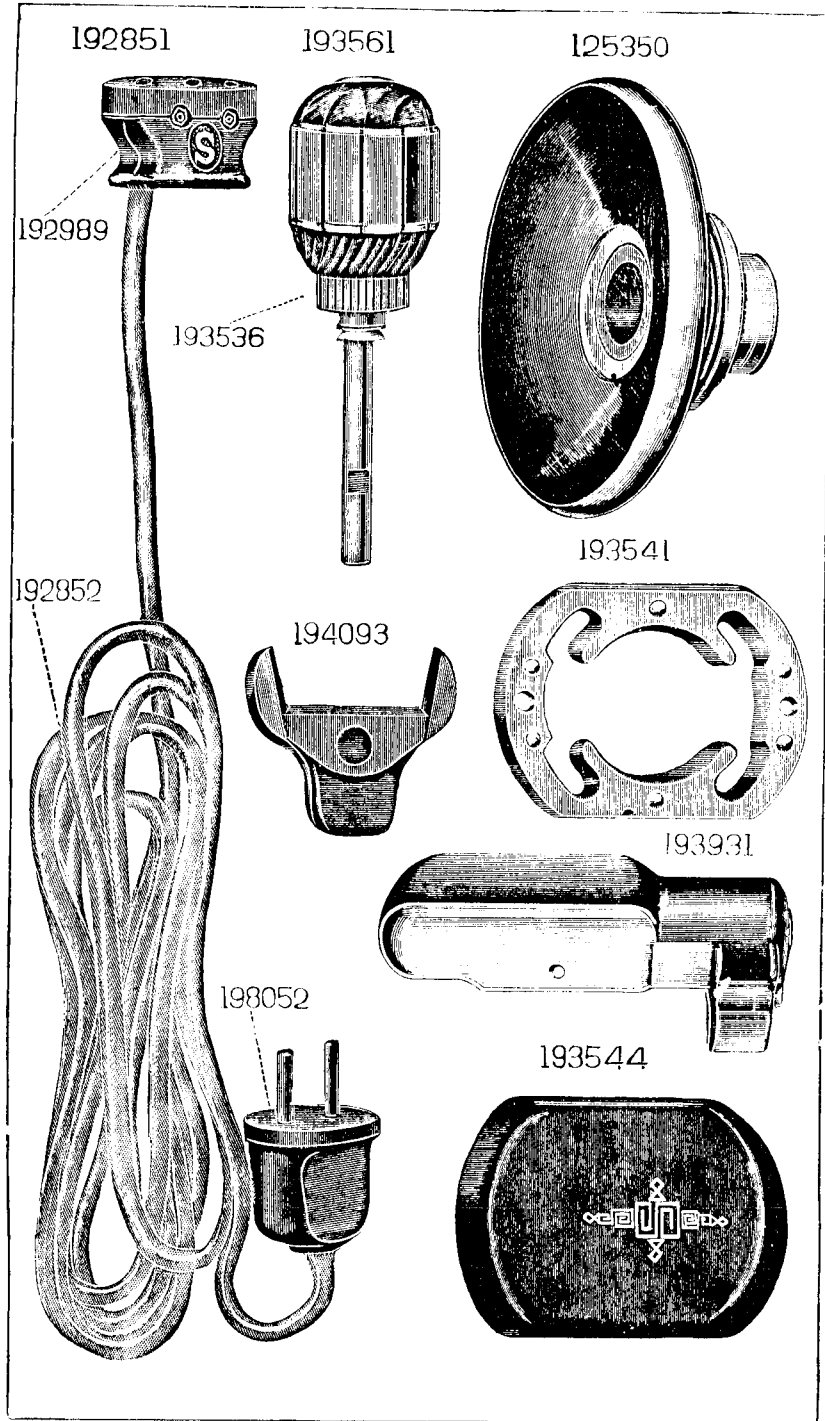

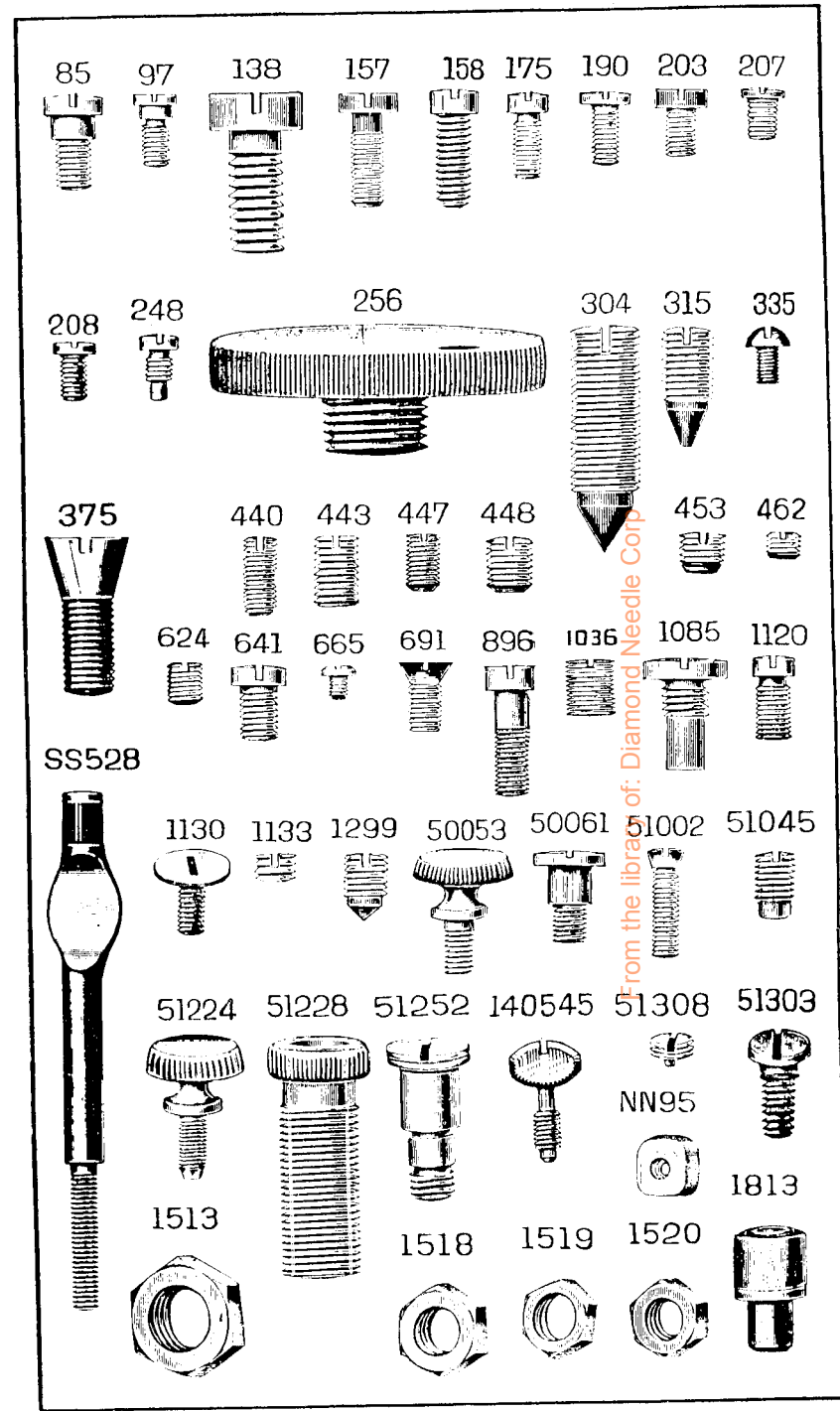
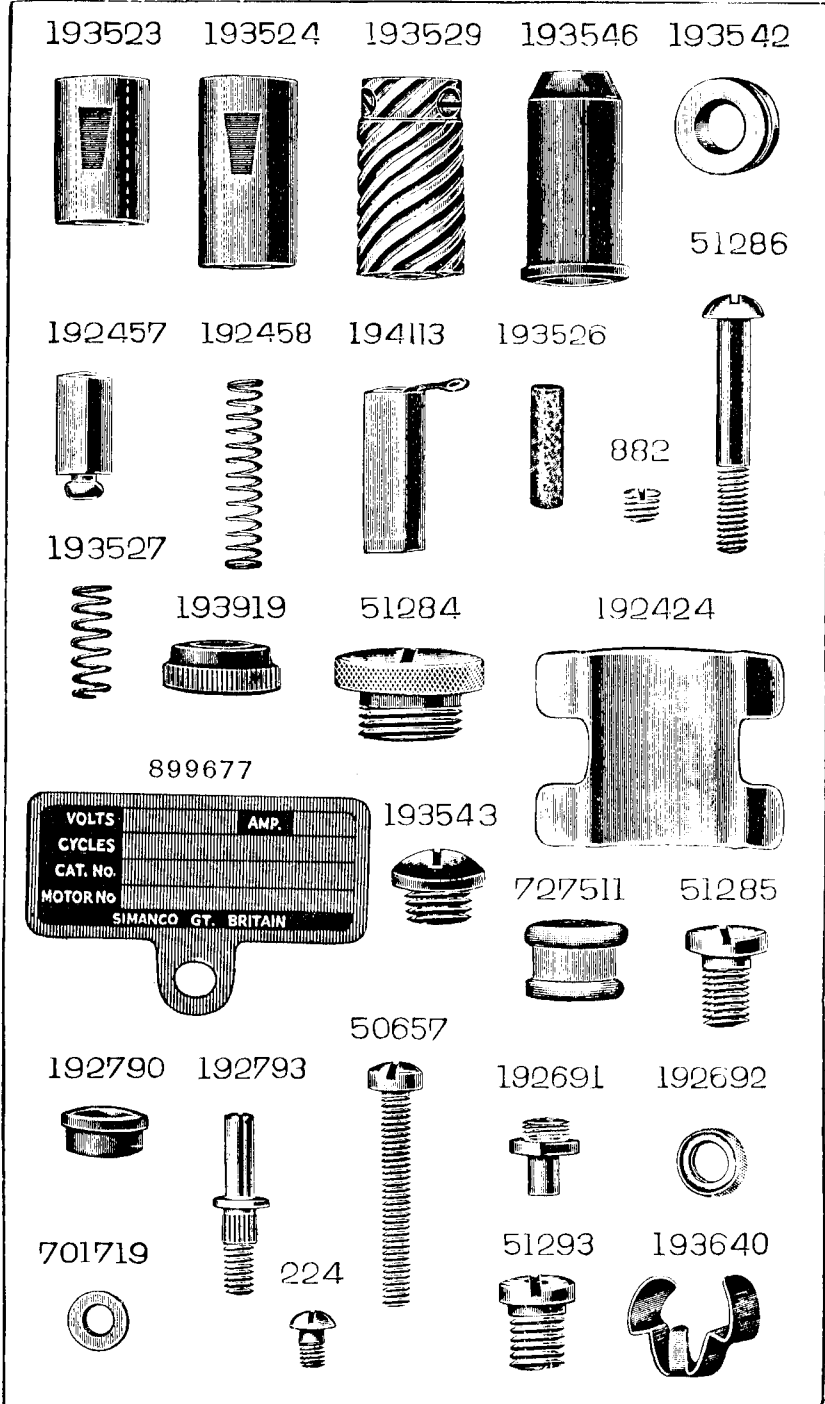

From the library of: Diamond Needle Corp.

1134 50617 50684 50996 51093 51281

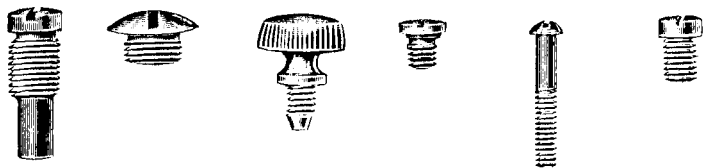

51294 51295 51319 51320 51367 51399

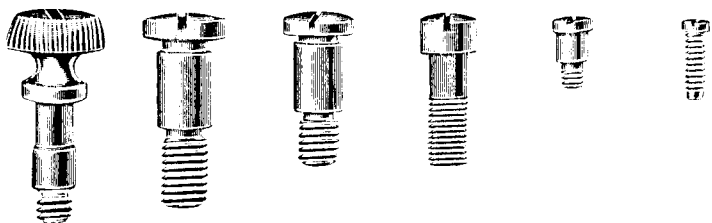

51401 51582



1768 51623

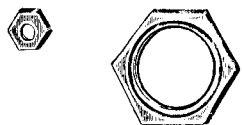

45306

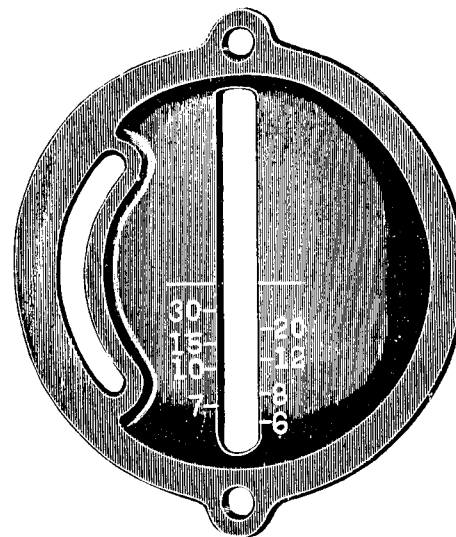

45308

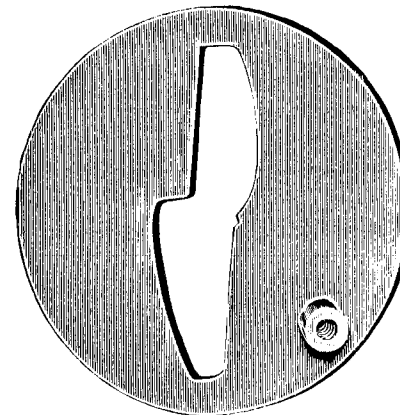

45305



1550



51312



45310



From the library of: Diamond Needle Corp

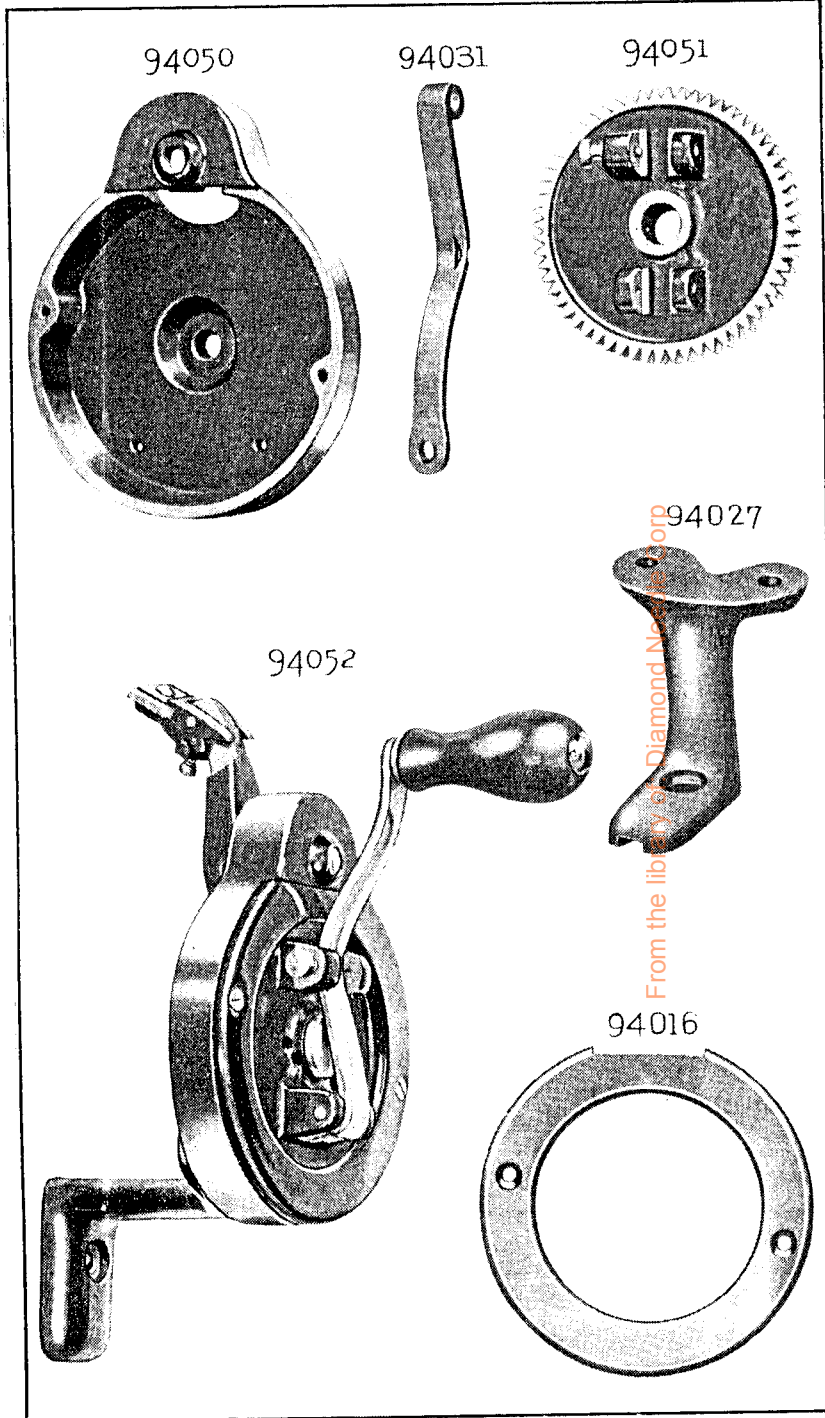
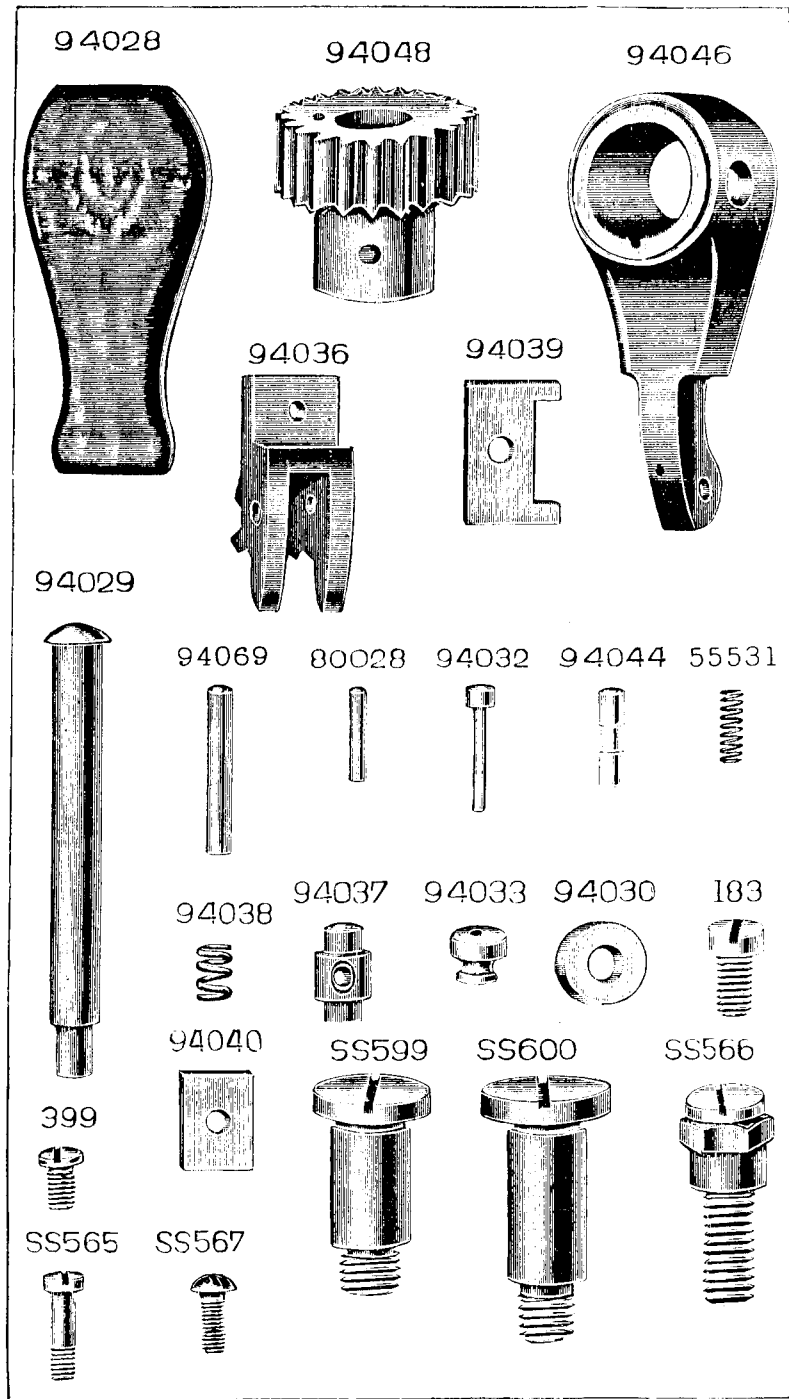

From the library of Diamond Net

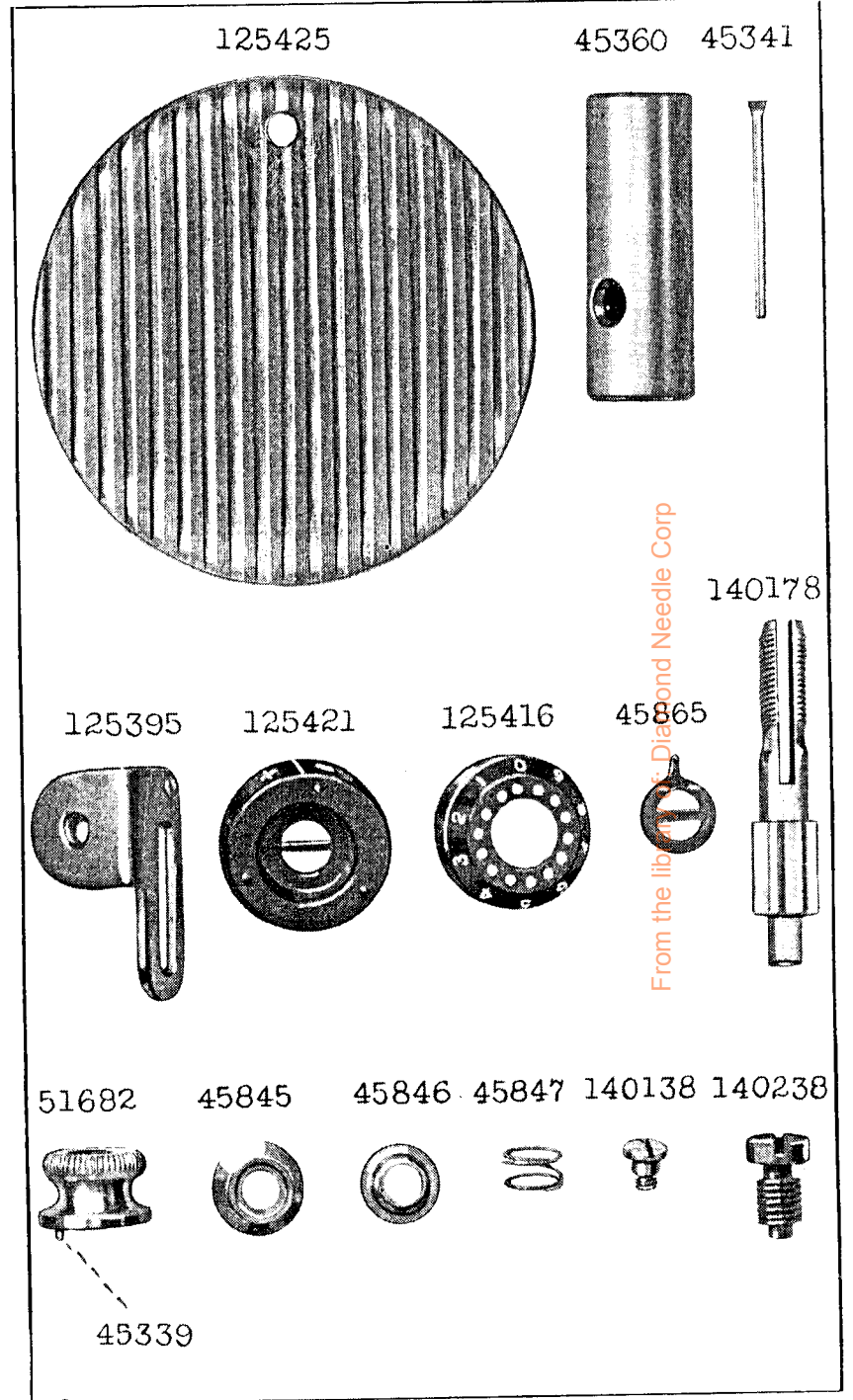
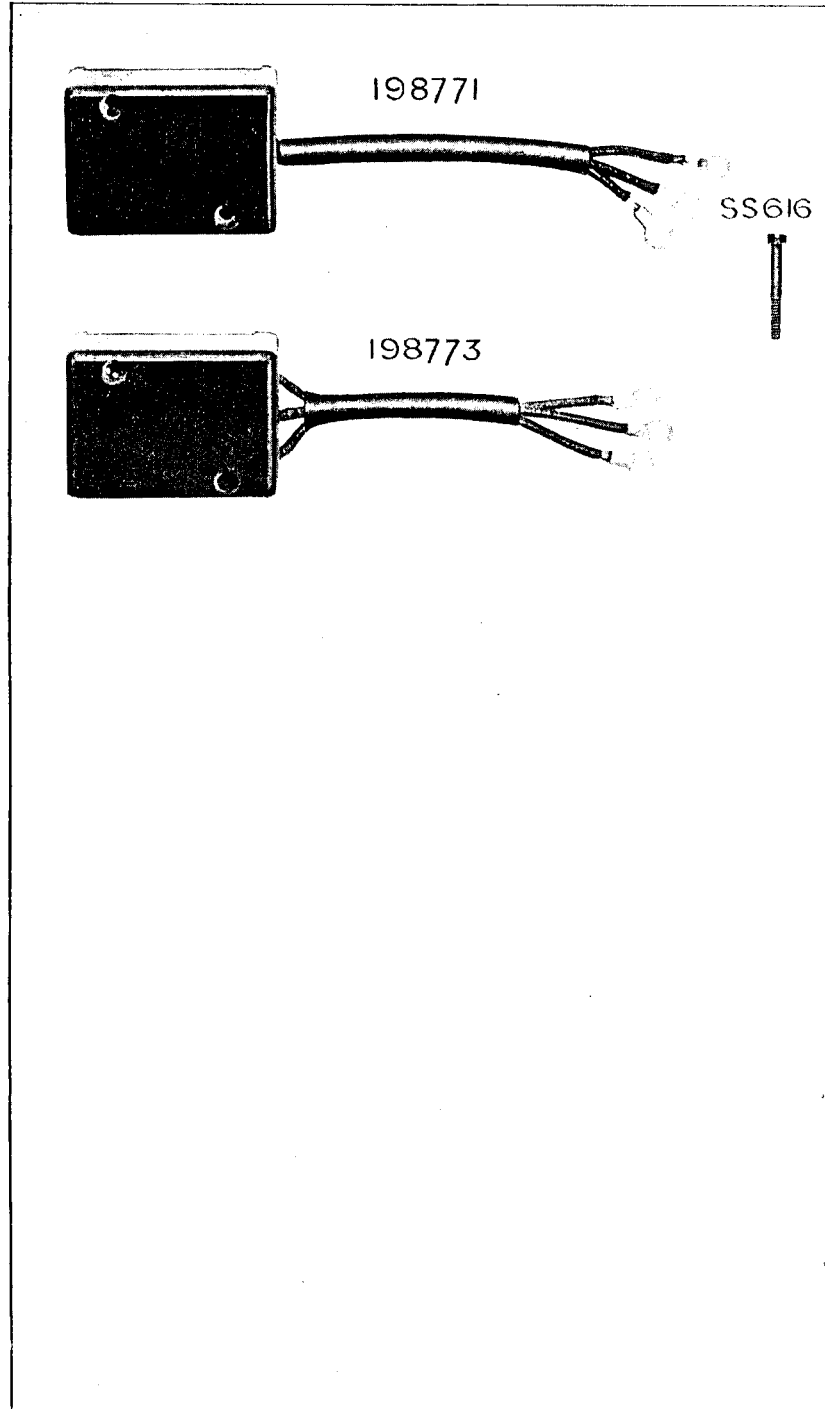

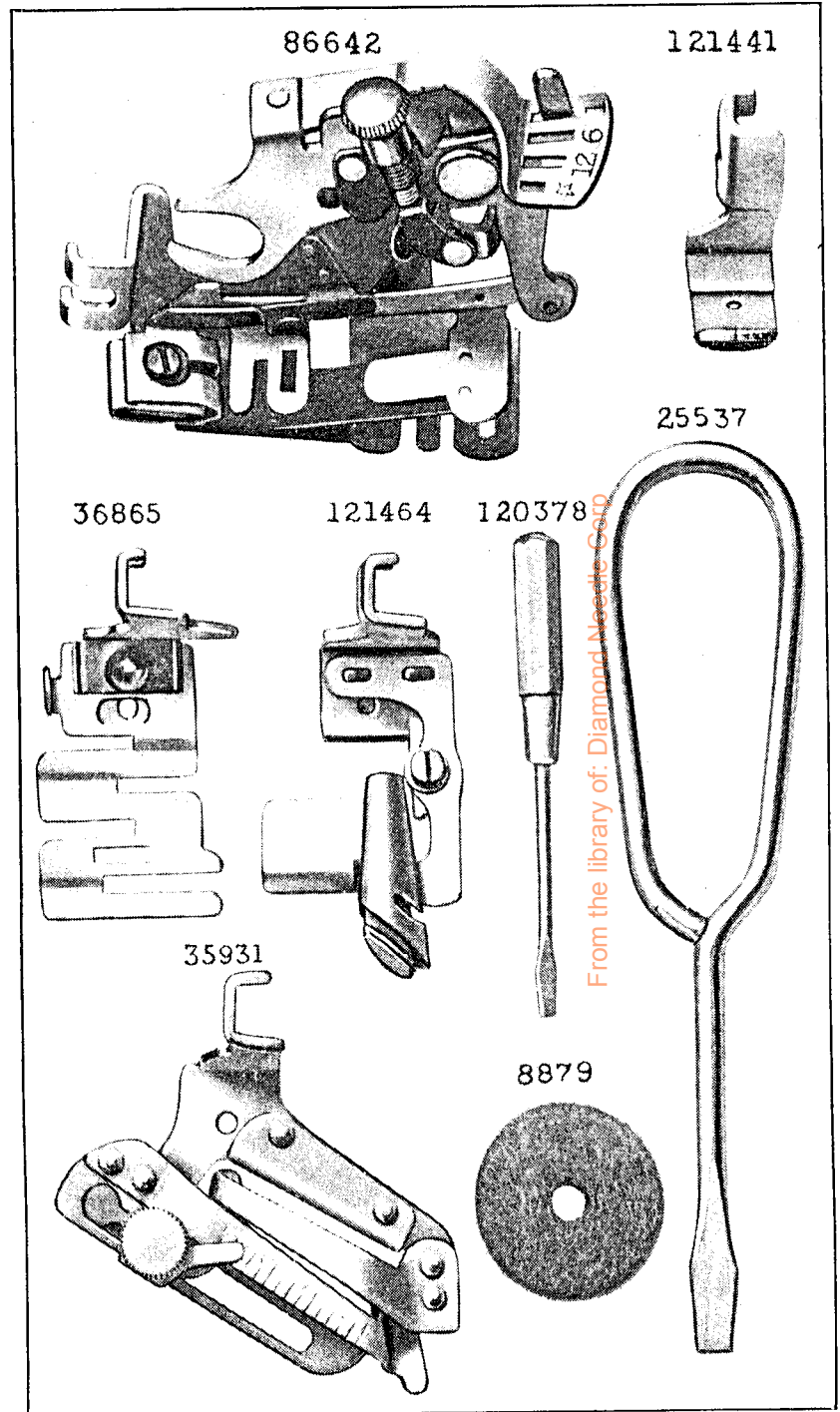
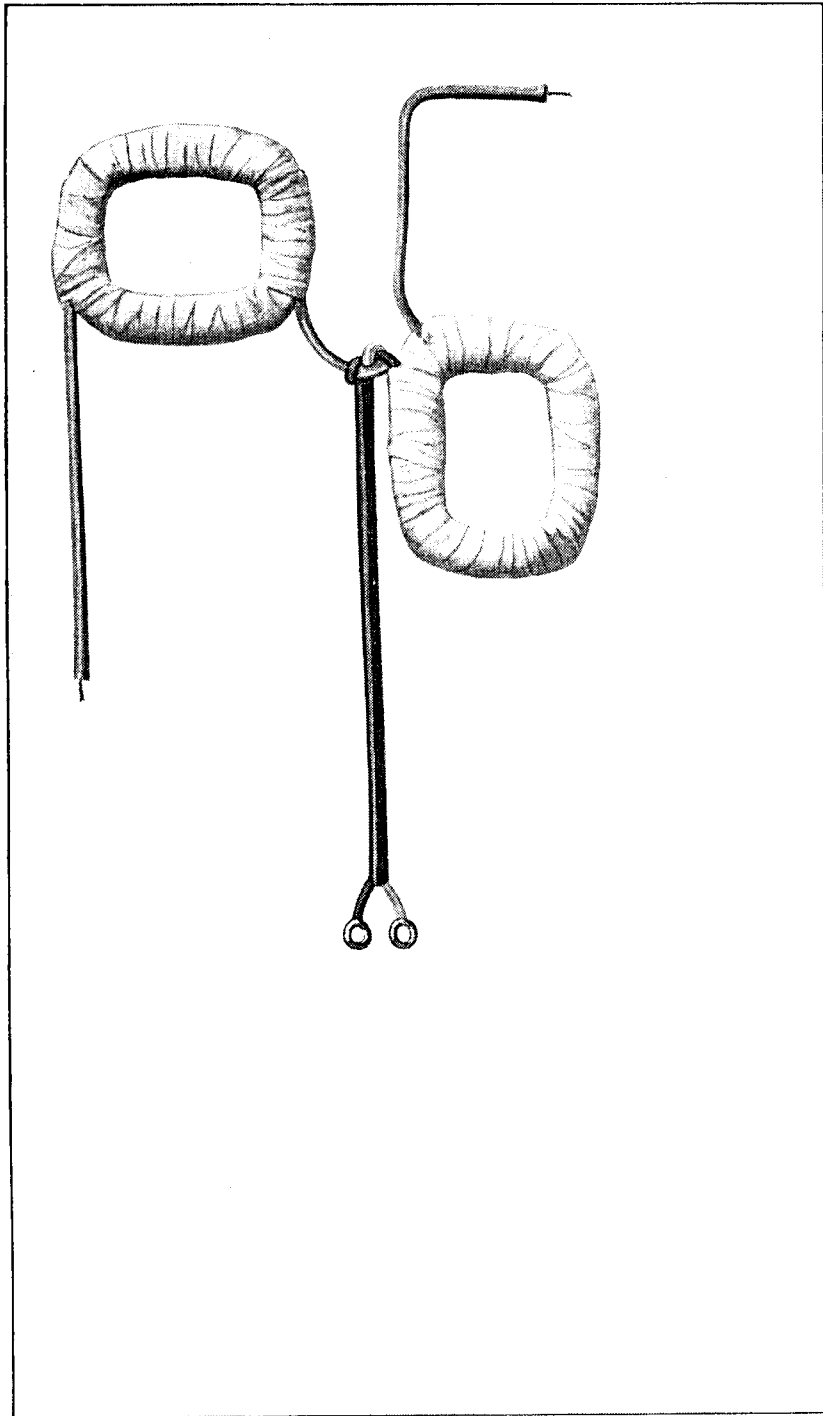

120914

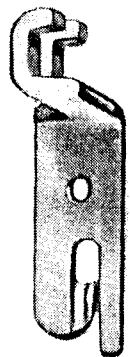

120855



121094

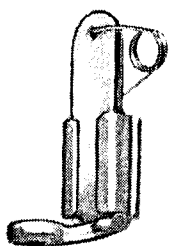

25539

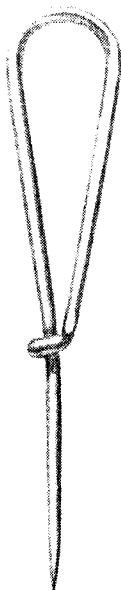

121877

140347

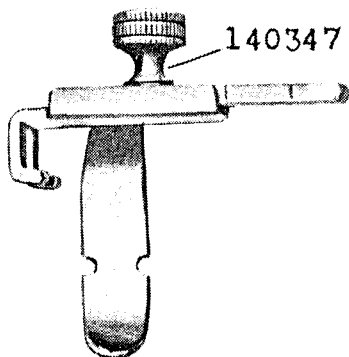

125035



25525

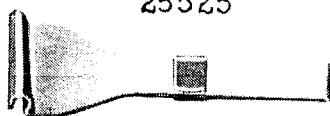

25527

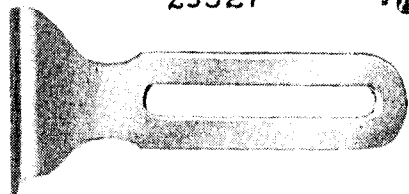

50053

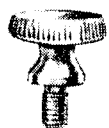

35932

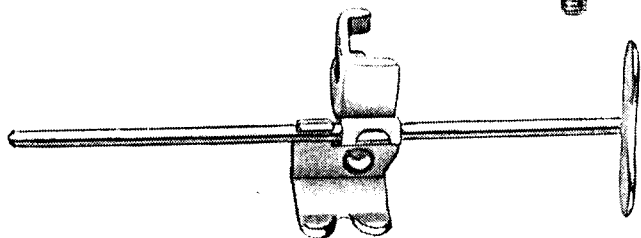



# Illustrated List of Parts for Class 201K Machines

## CONTENTS

	Page
Parts complete for 201K1, 201K3 and 201K4 Machines	41
Parts special to 201K2 Machine	47
Attachments	58
Bobbin Winder	56
Embroidery Hoops	60
Hand Attachment	61
Obsolete Parts	62
Numerical List of Parts	67

From the library of: Diamond Needle Corp

## INSTRUCTIONS FOR ORDERING

In ordering from this List, the prefix and affix letters with the part number **MUST BE** quoted exactly as they are shown in the first column.

A number always indicates the same part in whatever List it may appear, or for whatever machine.

The affix letters (where shown) indicate the style of finish, as follows:—

- A. Hardened, Polished, Nickel Plated and Buffed.
- A.A. Buffed and Chromium Plated.
- A.B. Hardened, Polished, Buffed and Chromium Plated.
- A.C. Brown Baking Enamel Finish.
- A.D. Grey Baking Enamel Finish.
- A.E. Hardened, Bright Rumbled and Nickel Plated.
- A.F. Hardened, Bright Rumbled and Nickel Plated, Bright Rumbled and Chromium Plated.
- A.J. Polished, Nickel Plated and Chromium Plated.
- A.K. Hardened, Polished, Nickel Plated and Chromium Plated.
- A.L. Heat Treated for Toughness.
  - B. Polished, Nickel Plated and Buffed.
  - C. Hardened only.
- C.R. Hardened and Merlized.
- D. Polished only.
- E. Soft, not Polished.
- F. Hardened and Polished.
- F.J. Hardened, Polished and Nickel Plated.
- G. Bright Rumbled and Nickel Plated.
- H. Blued.
- J. Nickel Plated only.
- K. Hardened and Nickel Plated.
- L. Brass Plated.
- M. Oxidized.
- N. Japanned, Dull.
- P. Japanned, Bright.
- P.P. Wrinkle Finish.
- R. Merlized.
- S. Cadmium Plated.
- T. Copper Plated.
- T.A. Hardened, Polished, Copper and Nickel Plated and Buffed.
- T.B. Copper and Nickel Plated and Polished.
- T.J. Copper and Nickel Plated only.
- T.K. Hardened, Copper and Nickel Plated.
- T.L. Copper and Brass Plated.
- T.M. Copper Plated and Oxidized.
- U. Zinc Plated.
- V. Silver Plated.
- W. Polished and Nickel Plated.
- X. Black Oxide for Iron and Steel.
- X.C. Hardened and Black Oxide for Iron and Steel.
- Y. Black Nickel Plated only.
- Z. Chromium Plated.
- Z.A. Hardened, Polished, Nickel Plated, Buffed and Chromium Plated.
- Z.B. Polished, Nickel Plated, Buffed and Chromium Plated.
- Z.C. Hardened and Chromium Plated.
- Z.D. Polished and Chromium Plated.
- Z.G. Bright Rumbled, Nickel Plated, Bright Rumbled and Chromium Plated.
- Z.J. Nickel and Chromium Plated.
- Z.T. Copper and Chromium Plated.

Parts marked with an asterisk (\*) are furnished only when the repairs are made at Factory.

## PARTS COMPLETE

FOR

### Nos. 201K1, 201K3 and 201K4 Machines

Horizontal Rotating Hook ; Reverse Feed ; for Family Use.

No.	Plate								
*45201	—	<b>Arm</b>	...	...	...	...	...	...	...
45202	—	"	45201 with 443c, 15401, 32503, 45207, 45208, two each						448c and 15405
<i>NOTE: Due to the accuracy required for Gear alignment, Arm cannot be supplied separately and can only be sent out as a unit, Arm and Bed assembled.</i>									
4389	2050	<b>Arm</b>	Dowel Pin (2)	...	...	...	...	...	...
125331	2050	"	Oil Pad (felt), for oiling Arm Shaft (horizontal) Back						Bearing
125333	2050	"	"	"	"	Spring	...	...	...
125334	2050	"	"	"	"	Cap	...	...	...
	138c	2055	"	Screw (3)	...	...	...	...	...
45299	2042	"	Shaft (horizontal)	...	...	...	...	...	...
45316	2044	"	"	( " )	Bevel Gear (right hand spiral), with two				1259c
	1259c	2045	"	"	( " )	"	"	Set Screw	...
32503	2047	"	"	( " )	Bushing	...	...	...	...
	443c	2055	"	"	( " )	"	"	Set Screw	...
66643	2042	"	"	(upright)	...	...	...	...	...
45317	2044	"	"	( " )	Bevel Gear (lower, right hand spiral), with				two 1259c
	1259c	2045	"	"	( " )	"	"	Set Screw	...
45318	2044	"	"	( " )	"	"	"	(upper, left hand spiral), with	two 1259c
	1259c	2045	"	"	( " )	"	"	Set Screw	...
45207	2046	"	"	( " )	Bushing (lower)	...	...	...	...
	448c	2055	"	"	( " )	"	( " )	Set Screw	...
45208	2046	"	"	( " )	"	(upper)	...	...	...
	448c	2055	"	"	( " )	"	( " )	Set Screw	...
125425	2392	"	Side Cover	...	...	...	...	...	...
51224zb	2055	"	"	"	Thumb Screw	...	...	...	...
2007	2050	"	Spool Pin	...	...	...	...	...	...
8879	2050	"	"	"	Washer (cloth)	...	...	...	...
45209	2044	"	Top Cover with 45210	...	...	...	...	...	...
*45210	—	"	"	"	Hub	...	...	...	...
15282	1152	<b>Balance Wheel</b> , 2 1/4" pulley, for 201K1 and 201K4 Machines	...	...	...	...	...	...	...
32672	1722	"	"	3 1/4" pulley, for 201K3 Machine	...	...	...	...	...
*45211	—	<b>Bed</b>	...	...	...	...	...	...	...

*NOTE: Due to the accuracy required for Gear alignment, Bed cannot be supplied separately and can only be sent out as a unit, Arm and Bed assembled.*

From the Library of: Diamond Needle Corp

No.	Plate					
256zb	2055	<b>Clamp Stop Motion Clamp Screw</b>	...	...	...	...
248za	2055	" " " " Stop Screw	...	...	...	...
2020	2050	" " " " Washer	...	...	...	...
45311	2046	" " " Flanged Bushing	...	...	...	...
45313	---	" " " " " 45311 with 256zb	...	...	...	...
51320c	2056	" " " " " Set Screw	...	...	...	...
45312	---	<b>Clamp Stop Motion, complete, Nos. 248za, 2020, 45313 and 51320c</b>	...	...	...	...
*45212	---	<b>Face Plate</b>	...	...	...	...
45213	2041	" " 45212 with 45214	...	...	...	...
50096zb	2056	" " Screw	...	...	...	...
45359	2043	" " Thread Guard	...	...	...	...
45214	2043	" " " " 45359 with 125121	...	...	...	...
125424	2043	" " " " Rivet	...	...	...	...
50684zb	2056	" " Thumb Screw	...	...	...	...
45215	2041	<b>Feed Bar</b>	...	...	...	...
315c	2055	" " Screw Centre (2)	...	...	...	...
1519j	2055	" " " " Nut (2)	...	...	...	...
45322	2046	" Cam and Feed Lifting Eccentric (counterbalanced) with 1299c	...	...	...	...
1299c	2055	" " " " " " Position Screw	...	...	...	...
45217	2042	" Connecting Rod with 45218, 125044 and two 896c	...	...	...	...
*45218	---	" " " " Cap	...	...	...	...
896c	2055	" " " " Screw	...	...	...	...
375c	2055	" " " " Hinge Screw	...	...	...	...
1518j	2055	" " " " " Nut	...	...	...	...
125044	2050	" " " " Oil Pad (felt)	...	...	...	...
45219	2043	" Dog (12 teeth, 14 teeth to the inch)	...	...	...	...
208al	2055	" " Screw (2)	...	...	...	...
45222	2042	" Forked Connection with 175j	...	...	...	...
45291	---	" " " 45222 with 125335	...	...	...	...
175j	2055	" " " Adjusting Screw	...	...	...	...
51252c	2055	" " " Hinge Screw (eccentric)	...	...	...	...
1520j	2055	" " " " Nut	...	...	...	...
125047	2047	" " " Slide Block	...	...	...	...
125335	---	" " " " " 125047 with 1085c	...	...	...	...
1085c	2055	" " " " " Screw Stud	...	...	...	...
45223	2012	" Lifting Rock Shaft	...	...	...	...
45224	---	" " " " complete, Nos. 45223 and 45226	...	...	...	...
45225	2044	" " " " Crank with 157j	...	...	...	...
45226	---	" " " " " 45225 with 45220, 45221, 50061j and 51294j	...	...	...	...
157j	2055	" " " " " Clamping Screw	...	...	...	...
304c	2055	" " " " " Screw Centre (2)	...	...	...	...
1513j	2055	" " " " " Nut (2)	...	...	...	...

No.	Plate					
45325	2046	<b>Feed Regulator</b>	...	...	...	...
45326	---	" " 45325 with 125381	...	...	...	...
51295e	2056	" " Hinge Screw	...	...	...	...
8217	2050	" " " " Friction Washer	...	...	...	...
45305	2058	" Reversing Handle	...	...	...	...
125381	---	" " " 45305 with 1550j	...	...	...	...
1550j	2058	" " " " Nut	...	...	...	...
45229	2042	" Rock Shaft	...	...	...	...
304c	2055	" " " Screw Centre (2)	...	...	...	...
1513j	2055	" " " " " Nut (2)	...	...	...	...
45220	2044	" Throw-out Lever with 1813	...	...	...	...
50061j	2055	" " " Hinge Screw	...	...	...	...
1813	2055	" " " Roller and Stud	...	...	...	...
51294x	2056	" " " Thumb Screw	...	...	...	...
45221	2043	" " " " " Retaining Ring	...	...	...	...
51045c	2055	<b>Machine Hinge Connection Set Screw (2)</b>	...	...	...	...
45323	2043	<b>Needle Bar</b> with 32519 and 45324	...	...	...	...
66558	2050	" " Bushing	...	...	...	...
45353	---	" " " 66558 with 665zb and 3354	...	...	...	...
1133c	2055	" " " Set Screw	...	...	...	...
*45231	---	" " Connecting Link with 51002c	...	...	...	...
45232	2043	" " " " 45231 with 66559	...	...	...	...
45233	---	" " " " 45232 with 1130c and 32578	...	...	...	...
51002c	2055	" " " " Adjusting Screw	...	...	...	...
1130c	2055	" " " " Cap Screw	...	...	...	...
66559	2047	" " " " Stud with 1353c	...	...	...	...
1353c	2045	" " " " Set Screw	...	...	...	...
45234	2046	" " Crank with 1036c and 1134c	...	...	...	...
1134c	2056	" " " Position Screw	...	...	...	...
21360	2047	" " Hole Plug	...	...	...	...
*45324	2048	" " Plug	...	...	...	...
45354	2044	" " Thread Guard	...	...	...	...
665zb	2055	" " " " Screw	...	...	...	...
66561	2047	" " Timing Gauge	...	...	...	...
45334	---	" Clamp with 140545zc	...	...	...	...
45285	2047	" " 45334 with 51308al	...	...	...	...
45355	2044	" " Gib and Thread Guard	...	...	...	...
51308al	2055	" " Position Screw	...	...	...	...
140545zc	2055	" " Thumb Screw	...	...	...	...
32519	2045	" Stop Pin	...	...	...	...
8366	2041	<b>Presser Bar</b>	...	...	...	...
45237	2043	" " Guide Bracket with 453c	...	...	...	...
453c	2055	" " " " Set Screw	...	...	...	...
66564	2047	" " Lifter	...	...	...	...
85c	2055	" " " Hinge Screw	...	...	...	...
32675	2047	" " Spring	...	...	...	...

No.	Plate						
2070	2050	<b>Presser Bar</b>	Spring Washer	...	...	...	...
45329	---	"	Foot Hinge Pin	...	...	...	...
45319	---	"	"	Plate	...	...	...
*45320	---	"	"	Shank	...	...	...
45321	2047	<b>Presser Foot</b>	(hinged), complete, Nos. 45319, 45320 and 45329	...	...	...	...
51224zb	2055	"	"	Thumb Screw	...	...	...
*51228zb	2055	<b>Pressure Regulating Thumb Screw</b>	...	...	...	...	...
66773	---	"	"	"	51228zb with 66752	...	...
66752	2050	"	"	"	Plug (felt wick)	...	...
*45270	2045	<b>Rotating Hook</b>	...	...	...	...	...
45271	---	"	"	45270 with 45281 and two 51306e	...	...	...
45272	---	"	"	45271 with two each 707e and 45279	...	...	...
45273	2045	<b>Rotating Hook</b> , complete, Nos. 45272 and 45278	...	...	...	...	...
45274	---	<b>Rotating Hook and Bobbin Case</b> , complete, Nos. 45273 and 45276	...	...	...	...	...
32522	2047	"	"	Bobbin	...	...	...
*45275	---	"	"	"	Case	...	...
45276	2045	"	"	"	complete, Nos. 1172c, 1173d, 45275, 45277, 45280 and 51302e	...	...
45277	2045	"	"	"	Finger	...	...
51302e	2045	"	"	"	Screw	...	...
45292	2045	"	"	"	Position Plate	...	...
45241	---	"	"	"	45292 with 45293 and two 239e	...	...
45293	2045	"	"	"	Loop Guard	...	...
239e	2045	"	"	"	"	Screw	...
207f	2055	"	"	"	"	Screw (2)	...
45278	2045	"	"	"	Retaining Ring	...	...
45279	2045	"	"	"	Spring	...	...
707e	2045	"	"	"	"	Screw	...
1172c	2045	"	"	"	Tension Regulating Screw	...	...
45280	2045	"	"	"	Spring	...	...
1173d	2045	"	"	"	"	Screw	...
45242	2041	"	"	"	Driving Shaft	...	...
45853	2044	"	"	"	Bevel Gear (back, left hand spiral), with two 1259c	...	...
45244	2042	<b>Rotating Hook Driving Shaft</b>	Bevel Gear (back) Cover, complete, Nos. 45286 and 45287	...	...	...	...
*45286	---	<b>Rotating Hook</b>	Driving Shaft Bevel Gear (back) Cover Body	...	...	...	...
*45287	---	"	"	"	( " ) Cover Body End Cap	...	...

No.	Plate						
203e	2055	<b>Rotating Hook</b>	Driving Shaft Bevel Gear (back) Cover	...	...	...	...
1259c	2045	"	"	"	"	"	( " ) Set Screw (2)
45852	2044	"	"	"	"	"	(front, right hand spiral), with two 1259c
45246	2042	"	"	"	"	"	(front) Cover
207e	2055	"	"	"	"	"	( " ) " Screw (2)
1259c	2045	"	"	"	"	"	( " ) Set Screw
45247	2046	"	"	"	"	"	Bushing (back)
448c	2055	"	"	"	"	"	( " ) Set Screw
45360	2392	"	"	"	"	"	(front)
140238c	2392	"	"	"	"	"	( " ) Set Screw
66581	2043	"	"	"	"	"	Collar with two 50150c (2)
50150c	2045	"	"	"	"	"	Screw
45281	2045	"	"	"	"	"	Needle Guard
51306e	2045	"	"	"	"	"	Screw (2)
45282	2045	"	"	"	"	"	Position Pin
50463f	2045	"	"	"	"	"	Screw
45249	2043	"	"	"	"	"	Shaft with 45282
45349	2044	"	"	"	"	"	Bevel Gear (left hand spiral), with two 1120c
45251	2042	"	"	"	"	"	Cover
207e	2055	"	"	"	"	"	Screw (2)
1120c	2055	"	"	"	"	"	Set Screw (2)
45252	2046	"	"	"	"	"	Flanged Bushing
440c	2055	"	"	"	"	"	Set Screw
45356	2043	"	"	"	"	"	Slide
15357	2043	"	"	"	"	"	Spring
51282j	2044	"	"	"	"	"	Screw
45358	---	<b>Rotating Hook Slide</b> , complete, Nos. 45356, 45357 and two 51282j	...	...	...	...	...
45345	2044	<b>Slack Thread Regulator</b>	and Tension Thread Guide	...	...	...	...
335zb	2055	"	"	"	"	"	Screw
45306	2058	<b>Stitch Indicator Plate</b>	...	...	...	...	...
335r	2055	"	"	"	"	"	Screw (2)
45307	---	"	"	"	"	"	Regulating Plate
45308	2058	"	"	"	"	"	45307 with 45289
45309	---	"	"	"	"	"	45308 with 45306, 45310, 51312zb and 125400
51312zb	2058	"	"	"	"	"	Thumb Screw
*45289	---	"	"	"	"	"	Bushing
125400	2044	"	"	"	"	"	Friction Washer
45310	2058	"	"	"	"	"	Washer (fibre)
2102	2050	<b>Tension Disc</b>	...	...	...	...	...

No.	Plate						
125421	2392	<b>Tension Indicator</b>	...	...	...	...	...
125416	2392	"	"	Flange	...	...	...
45865	2392	"	"	"	Stop Washer	...	...
51682zb	2392	"	"	Regulating Thumb Nut with 45339	...	...	...
45339	2392	"	"	"	"	Engaging Pin	...
32573	2047	"	"	Releasing Lever	...	...	...
97e	2055	"	"	"	"	Hinge Screw	...
12329	2047	"	"	"	"	Spring	...
45341	2392	"	"	"	"	Pin	...
125314	2047	"	"	"	"	Spring	...
*140178zb	2392	"	"	"	"	Stud	...
45352	...	"	"	"	"	140178zb with 51682zb	...
447c	2055	"	"	"	"	Set Screw	...
45351	...	<b>Tension</b> (graduated), complete, Nos. 45341, 45343, 45352, 45865, 66774, 125314, 125416, 125421 and two 2102	...	...	...	...	...
26075	2050	<b>Thread Cutter and Holder</b>	...	...	...	...	...
8422	2050	<b>Thread Guard</b> (head of arm)	...	...	...	...	...
32578	2047	"	"	Take-up Crank	...	...	...
1036c	2055	"	"	"	"	Set Screw	...
45261	2044	"	"	"	"	Lever	...
45262	...	"	"	"	"	complete, Nos. 45261, 45261 and 45265	...
45263	...	"	"	"	"	45262 with 45233 and 66593	...
45264	2044	"	"	"	"	Hinge Stud	...
45265	2044	"	"	"	"	Link	...
66593	2044	"	"	"	"	"	Hinge Stud
447c	2055	"	"	"	"	"	Set Screw
66774	2043	"	"	"	"	Spring	...
45343	2043	"	"	"	"	Thread Guard	...
125319	2047	<b>Throat Plate</b> for 45219	...	...	...	...	...
691za	2055	"	"	"	"	Screw (2)	...
*15404	...	<b>Trade Mark</b>	...	...	...	...	...
15405	...	"	"	"	"	Rivet (2)	...
45350	...	<b>Drip Pan</b> with four wood screws $\frac{1}{2}$ " No. 5	...	...	...	...	...

## PARTS SPECIAL

TO

## No. 201K2 Machine

**Horizontal Rotating Hook ; Reverse Feed ; Solid Balance Wheel ; P.H. Motor and Singerlight ; for Family Use.**

*This machine is the same as No. 201K1 with the following exceptions :*

No.	Plate						
*45327	...	<b>Arm</b>	...	...	...	...	...
45328	...	"	45327 with 443c, 15104, 32503, 45207, 45208, two each 448c and 15405	...	...	...	...
125350zb	2052	<b>Balance Wheel</b> with 125358	...	...	...	...	...
125364	...	"	"	125350 with 125352 to 125355 and two 125385	...	...	...
125351	2048	"	"	Gear (textolite)	...	...	...
125352	2048	"	"	"	125351 with 125356 and 125357	...	...
125353	2048	"	"	"	Collar with three 51281c	...	...
51281c	2056	"	"	"	"	Set Screw	...
125354	2048	"	"	"	"	Spring	...
125385	2048	"	"	"	"	Cushion Pin (eccentric)	...
125355	2048	"	"	"	"	Retaining Washer	...
125356	2048	"	"	"	"	Stud	...
125357	...	"	"	"	"	"	Washer
125358	2048	"	"	"	"	Spring Stud	...
51280zb	2048	<b>Clamp Stop Motion Clamp Screw</b>	...	...	...	...	...
246za	2048	"	"	"	"	Stop Screw	...
125359	2048	"	"	"	"	Washer	...
45294	2048	"	"	"	"	Flanged Bushing	...
45295	...	"	"	"	"	"	45294 with 51280zb
45336	...	<b>Clamp Stop Motion</b> , complete, Nos. 246za, 45295, 51320c and 125359	...	...	...	...	...

## MOTOR PARTS

No.	Plate						
193555	...	Armature, complete, for P.H.K.3 Motor	...	...	...	...	...
193556	...	"	"	"	P.H.K.5	"	...
193557	...	"	"	"	P.H.K.6	"	...
193557	...	"	"	"	P.H.K.7	"	...
193558	...	"	"	"	P.H.K.8	"	...
193559	...	"	"	"	P.H.K.9	"	...
193560	...	"	"	"	P.H.K.10	"	...
193561	2052	"	"	"	P.H.K.11	"	...
193561	2052	"	"	"	P.H.K.12	"	...

No.	Plate				
193562	---	Armature, complete, for P.H.K.15 Motor	...	...	...
193563	---	" " " P.H.K.87 "	...	...	...
193564	---	" " " P.H.K.90 "	...	...	...
193560	---	" " " P.H.K.92 "	...	...	...
*193540	---	Armature Core, complete	...	...	...
*193528	---	" Shaft	...	...	...
193523	2054	" " Bearing Sleeve (commutator end)	...	...	...
447c	2055	" " " " ( " " ) Set Screw	...	...	...
193524	2054	" " " " (front end)	...	...	...
50617zb	2056	" " " " ( " " ) Cap Screw	...	...	...
447c	2055	" " " " ( " " ) Set Screw	...	...	...
193529	2054	" " Pinion (spiral), with two 462al	...	...	...
462al	2055	" " " Set Screw	...	...	...
193542	2054	" " Oil Sling	...	...	...
931275	---	" Wire Separator (linen)	...	...	...
194591	---	Brush (carbon) for 25 and 32 volts	...	...	...
192457	2054	" ( " ) " 50 to 145 volts (2)	...	...	...
193799	---	" ( " ) " 150 to 250 volts (2)	...	...	...
193543	2054	" Cap (2)	...	...	...
192458	2054	" Spring (2)	...	...	...
194113	2054	" Tube (2)	...	...	...
193546	2054	" " Insulating Bushing (2)	...	...	...
882c	2054	" " " " Set Screw (2)	...	...	...
193536	2052	Commutator, complete	...	...	...
193565	---	Field Coil, complete, for P.H.K.3 Motor	...	...	...
193568	---	Field Coil, complete, for P.H.K.5 Motor	...	...	...
193571	---	Field Coil, complete, for P.H.K.6 Motor	...	...	...
193574	---	Field Coil, complete, for P.H.K.7 Motor	...	...	...
193577	---	Field Coil, complete, for P.H.K.8 Motor	...	...	...
193580	---	Field Coil, complete, for P.H.K.9 Motor	...	...	...
193583	---	Field Coil, complete, for P.H.K.10 and P.H.K. 11 Motors	...	...	...
193586	---	Field Coil, complete, for P.H.K.12 Motor	...	...	...
193589	---	Field Coil, complete, for P.H.K.15 Motor	...	...	...
193592	---	Field Coil, complete, for P.H.K.87 Motor	...	...	...
193595	---	Field Coil, complete, for P.H.K.90 Motor	...	...	...
193598	---	Field Coil, complete, for P.H.K.92 Motor	...	...	...
727511	2054	" " Lead Bushing (rubber)	...	...	...
195834	---	" " " Terminal Clip (2)	...	...	...
192424	2054	" " Retainer (2)	...	...	...
193541	2052	" Core, complete	...	...	...
51286r	2054	" " Screw (2)	...	...	...
193526	2054	Grease Wick	...	...	...
193525	---	" " 193526 with 193527 (2)	...	...	...
193527	2054	" " Spring	...	...	...
51284r	2054	" " " Cap Screw (2)	...	...	...
193640	2054	" " " Retainer (2)	...	...	...

No.	Plate				
*192852	2052	Lead Cord	...	...	...
192851	2052	Lead Cord, complete, from lamp socket to three pin terminal, for Knee and Treadle Control, Nos. 192790, 192852, 192989 and Plug	...	...	...
†193544	2052	Motor Cover	...	...	...
224zb	2054	" " Screw (2)	...	...	...
†193522	2053	Motor Frame	...	...	...
†193545	2053	" " 193522 with 193523, 193524, two each 447c and 882c	...	...	...
†*193732	---	" " 193545 with 190zb, 45268, 45297, 51303zb, 51319zb, 125326, 125365 and 125462	...	...	...
† In ordering it is necessary to state class of machine					
51285c	2054	Motor Frame Screw (2)	...	...	...
899677	2054	Name Plate	...	...	...
192790	2054	Three-Pin Terminal Adaptor Bushing	...	...	...
*192643	---	" " (female half) Housing (upper)	...	...	...
*192644	---	" " ( " " ) " (lower)	...	...	...
51093r	2056	" " ( " " ) " Screw	...	...	...
1768r	2056	" " ( " " ) " " Nut	...	...	...
192692	2054	" " ( " " ) Insert Clamp	...	...	...
192691	2054	" " ( " " ) " Sleeve	...	...	...
192989	2052	Three-Pin Terminal (female half) complete, Nos. 192643, 192644, two each 1768r, 51093r, three each 192691 and 192692	...	...	...
*193933	---	Three-Pin Terminal (male half) and Singerlight Switch Compartment	...	...	...
*193934	---	" " ( " " ) " " " Compartment 193933 with three 192793	...	...	...
192793	2054	" " ( " " ) Post	...	...	...
51582	2056	" " ( " " ) " Thumb Nut	...	...	...
701719	2054	" " ( " " ) " Washer	...	...	...
193935	2053	Three-Pin Terminal (male half) and Singerlight Switch Compartment, complete, Nos. 193934, three each 51582 and 701719	...	...	...
194093	2052	Three-Pin Terminal (male half) Bracket	...	...	...
51293c	2054	" " ( " " ) " Screw	...	...	...
50657r	2054	" " ( " " ) Screw	...	...	...
190439	---	Tube, filled with Singer Lubricant for Electric Motors	...	...	...
190613	---	Tube 190439 with 190612	...	...	...
190612	---	" Carton (paper)	...	...	...

## PLUGS

No.	Plate	
198052	2052	Two-Pin Plug ... ..
198108	---	" " (Norwegian) ... ..
198138	---	" " (Danish) ... ..
198367	---	" " (Swiss) ... ..
97382	2053	Bayonet Plug, complete, Nos. 97383 and 97384 ... ..
97383	2053	" " Body for 97382 ... ..
97384	2053	" " Cover for 97382 ... ..

## SINGERLIGHT No. 193930

No.	Plate	
193911	2053	Singerlight Lamp Socket ... ..
194050	2053	" " " 193911 with 193912, 194083, two each 51399e and 193915
193912	2053	" " " Cap with 193913 ... ..
*193913	---	" " " " Insert ... ..
51399e	2056	" " " " Screw ... ..
51367zb	2056	" " " " Screw ... ..
701994	2053	" " " " Insulating Washer ... ..
193914	---	" " " Terminal Lug ... ..
191981	---	" " " " Plunger ... ..
191980	---	" " " " " Housing ... ..
191982	---	" " " " " Spring ... ..
193915	---	Singerlight Lamp Socket Terminal, complete, Nos. 191980 to 191982 and 193914
*194074	---	Singerlight Lead (yellow tracer thread) for 194073 ... ..
194084	2053	" " (white) for 194083 ... ..
195834	---	" " Terminal Clip ... ..
194073	2053	Singerlight Lead (yellow tracer thread), complete, Nos. 194074 and 195834 for 194083 ... ..
194083	---	Singerlight Lead, complete, Nos. 194073, 194075 and 194084 ... ..
194075	2053	" " Tube, 10 $\frac{1}{8}$ " long (wiremould) ... ..
194082	2053	" " " Clamp ... ..
624c	2055	" " " " Set Screw ... ..
194085	---	" " " Clamping Plate (fibre) ... ..
51401e	2056	" " " " Screw ... ..
193931	2052	Singerlight Shade and Lamp Socket Housing with 51401e ... ..
*194273	2053	Singerlight Toggle Switch with 193919 ... ..
*193893	---	" " " Lead ... ..
195834	---	" " " Terminal Clip ... ..
193892	2053	Singerlight Toggle Switch Lead, complete, Nos. 193893 and 195834

No.	Plate	
51623	2056	Singerlight Toggle Switch Lock Nut ... ..
193919	2054	" " " Thumb Nut (moulded) ... ..
194274	2053	Singerlight Toggle Switch with Lead, complete, Nos. 51623, 193892 and 194273
193930	---	Singerlight (less lamp and switch), complete, Nos. 51367zb, 193931, 194050, 194085 and 701994
641j	2055	" Screw ... ..

## SINGERLIGHT LAMP

No.	Plate	
194120	---	Singerlight Lamp ... ..

NOTE: When ordering lamps for Singerlights, it is necessary to state the exact voltage required.

Example: 194120, 240 volts.

RADIO NOISE ELIMINATORS  
for No. 201K2 Machine

No.	Plate	
198769	---	Eliminator .1 + .1 Microfarads, with two fuses, Nos. 198775 and 198778 ... ..
198771	2310	Eliminator 198769 with 194525, 194526, 198770 and three 198414 and three 198414
198768	---	Eliminator, complete, Nos. 198771 and two SS616 ... ..
SS616	2310	Eliminator Fastening Screw ... ..

For No. 201K2 Machine  
(when grounded)

No.	Plate	
198779	---	Eliminator .1 + .1 + .005 Microfarads, with two fuses, Nos. 198776 and 198778 ... ..
198773	2310	Eliminator 198779 with 194525, 194526, 198771 and three 198414
198772	---	Eliminator, complete, Nos. 198773 and two SS616 ... ..
SS616	2310	Eliminator Fastening Screw ... ..

## BOBBIN WINDER FOR

### Nos. 201K1, 201K3 and 201K4 Machines

No.	Plate		...	...	...	...	...
15072	2050	<b>Bobbin Position Pin</b>	...	...	...	...	...
†125324	2049	<b>Bracket</b> (belt cover)	...	...	...	...	...
158e	2055	" Screw (2)	...	...	...	...	...
66670	2050	<b>Frame</b>	...	...	...	...	...
45297	---	" 66670 with 15288 and 66671	...	...	...	...	...
51319zb	2056	" Hinge Screw	...	...	...	...	...
66601	2050	" Spring	...	...	...	...	...
15287	2050	<b>Friction Ring</b> (rubber)	...	...	...	...	...
15288	2050	<b>Pulley</b>	...	...	...	...	...
66671	2049	<b>Spindle</b> with 15072	...	...	...	...	...
2007	2050	<b>Spool Pin</b>	...	...	...	...	...
8879	2050	" " Washer (cloth)	...	...	...	...	...
45268	2049	<b>Stop Latch</b>	...	...	...	...	...
51303zb	2055	" " Hinge Screw	...	...	...	...	...
125462	2050	" " Spring	...	...	...	...	...
125395	2392	<b>Tension Bracket</b>	...	...	...	...	...
125396	---	" " complete, Nos. 45845 to 45847, 125395 and 140138b	...	...	...	...	...
193zb	2049	" " Screw	...	...	...	...	...
7071	2050	" " " Washer	...	...	...	...	...
45845	2392	" Disc	...	...	...	...	...
45847	2392	" " Spring	...	...	...	...	...
45846	2392	" " " Disc	...	...	...	...	...
140138b	2392	" Screw	...	...	...	...	...
125326	2050	<b>Tripping Arm</b>	...	...	...	...	...
190zb	2055	" " Screw	...	...	...	...	...
45269	2049	<b>Bobbin Winder</b> , complete, Nos. 190zb, 15287, 45268, 45297, 51303zb, 51319zb, 66601, 125324, 125326 and 125462	...	...	...	...	...

† In ordering it is necessary to state class of machine.

## BOBBIN WINDER PARTS FOR

### No. 201K2 Machine

No.	Plate		...	...	...	...	...
15072	2050	<b>Bobbin Position Pin</b>	...	...	...	...	...
66670	2050	<b>Frame</b>	...	...	...	...	...
45297	---	" 66670 with 15288 and 66671	...	...	...	...	...
51319zb	2056	" Hinge Screw	...	...	...	...	...
125365	2049	" Spring	...	...	...	...	...
15287	2050	<b>Friction Ring</b> (rubber)	...	...	...	...	...
15288	2050	<b>Pulley</b>	...	...	...	...	...
66671	2049	<b>Spindle</b> with 15072	...	...	...	...	...
2007	2050	<b>Spool Pin</b>	...	...	...	...	...
8879	2050	" " Washer (cloth)	...	...	...	...	...
45268	2049	<b>Stop Latch</b>	...	...	...	...	...
51303zb	2055	" " Hinge Screw	...	...	...	...	...
125462	2050	" " Spring	...	...	...	...	...
125395	2392	<b>Tension Bracket</b>	...	...	...	...	...
125396	---	" " complete, Nos. 45845 to 45847, 125395 and 140138b	...	...	...	...	...
193zb	2049	" " Screw	...	...	...	...	...
7071	2050	" " " Washer	...	...	...	...	...
45845	2392	" Disc	...	...	...	...	...
45847	2392	" " Spring	...	...	...	...	...
45846	2392	" " " Disc	...	...	...	...	...
140138b	2392	" Screw	...	...	...	...	...
125326	2050	<b>Tripping Arm</b>	...	...	...	...	...
190zb	2055	" " Screw	...	...	...	...	...

From the library of: Diamond Needle Corp.



# ATTACHMENTS

## ATTACHMENT SET

(Supplied with Machines to Great Britain)

No.	Plate						
121464	2574	Binder ...	...	...	...	...	...
36865	2574	Edge Stitcher ...	...	...	...	...	...
121441	2574	Gathering Foot (double toe)	...	...	...	...	...
35931	2574	Hemmer (adjustable)	...	...	...	...	...
15 × 1	---	Needles (6)	...	...	...	...	...
86642	2574	Ruffler ...	...	...	...	...	...
25537	2574	Screw Driver (machine)	...	...	...	...	...
120378	2574	" " (bobbin case)	...	...	...	...	...
8879	2574	Spool Pin Washer (cloth)	...	...	...	...	...
160810	---	Set of Attachments, complete, Nos. 25537, 35931, 36865, 86642, 120378, 121441, 121464, two 8879 and six needles ...	...	...	...	...	...
120855	2575	Hemmer (foot) $\frac{5}{8}$ " hem ...	...	...	...	...	...
32522	2047	Rotating Hook Bobbin (3)	...	...	...	...	...
120861	---	Tin of Oil (3 oz.)	...	...	...	...	...

The following may be purchased separately :

25525	2575	Bias Gauge ...	...	...	...	...	...
25527b	2575	Cloth Guide ...	...	...	...	...	...
50053b	2575	" " and Under Braider Thumb Screw	...	...	...	...	...
120914	2575	Feller (foot) ...	...	...	...	...	...
35932	2575	Quilter ...	...	...	...	...	...
121170	909	Ruffler Shirring Plate ...	...	...	...	...	...
25539	2575	Stiletto ...	...	...	...	...	...
36583	1956	Tucker ...	...	...	...	...	...
121547	909	Under Braider ...	...	...	...	...	...

## ART WORK AND DARNING

No.	Plate						
85893	1956	Embroidery Foot (for art work) ...	...	...	...	...	...
121094	2575	Spring Darning Foot ...	...	...	...	...	...

## CORDING FEET

FOR STITCHING ON EDGE AND INSERTING CORD

No.	Plate						
125035	2575	Presser Foot for sewing on left side of needle	...	...	...	...	...
121875	---	Presser Foot ...	...	...	...	...	...
140347w	2575	" " Adjusting Thumb Screw	...	...	...	...	...
121876	---	" " Body ...	...	...	...	...	...
121877	2575	Presser Foot (adjustable for sewing on the right or left side of the needle), complete, Nos. 121875, 121876 and 140347w, for Cording and Slide Fastener Work	...	...	...	...	...

From the Library of: Diamond Needle Corp

## IMITATION HEMSTITCHING ATTACHMENT

No.	Plate						
120687	1956	with Yielding Presser Plate ...	...	...	...	...	...

## EMBROIDERY HOOPS (PLAIN)

(BIRCH)

No.	Plate								
87586	---	Round, $5\frac{3}{8}$ " diam. $\times$ $7\frac{m}{m}$ " high	...	...	...	...	...	...	...
96416	---	" 7" " $\times$ $7\frac{m}{m}$ " "	...	...	...	...	...	...	...
87589	1221	" 8" " $\times$ $7\frac{m}{m}$ " "	...	...	...	...	...	...	...
87593	---	" 10" " $\times$ $\frac{7}{16}$ " "	...	...	...	...	...	...	...
87595	---	" 12" " $\times$ $\frac{1}{2}$ " "	...	...	...	...	...	...	...
96422	1221	Oval, $9" \times 4\frac{1}{2}" \times 7\frac{m}{m}$ " high	...	...	...	...	...	...	...
87597	---	" $12" \times 5\frac{1}{2}" \times 7\frac{m}{m}$ " "	...	...	...	...	...	...	...

## EMBROIDERY HOOPS (WITH CLAMP)

(BIRCH)

No.	Plate								
96417	---	Round, $5\frac{3}{8}$ " diam. $\times$ $7\frac{m}{m}$ " high, with SS528j, NN95j, two 96425 and four 96427	...	...	...	...	...	...	...
96418	---	" 7" " $\times$ $7\frac{m}{m}$ " " " SS528j, NN95j, two 96426 and four 96427	...	...	...	...	...	...	...
96419	---	" 8" " $\times$ $7\frac{m}{m}$ " " " SS528j, NN95j, two 96426 and four 96427	...	...	...	...	...	...	...
96420	---	" 10" " $\times$ $\frac{7}{16}$ " " " SS528j, NN95j, two 96426 and four 96427	...	...	...	...	...	...	...
96421	---	" 12" " $\times$ $\frac{1}{2}$ " " " SS528j, NN95j, two 96844 and four 96845	...	...	...	...	...	...	...
96423	---	Oval, $9" \times 4\frac{1}{2}" \times 7\frac{m}{m}$ " high, with SS528j, NN95j, 96425, 96426 and four 96427	...	...	...	...	...	...	...
96424	---	" $12" \times 5\frac{1}{2}" \times 7\frac{m}{m}$ " " " SS528j, NN95j, 96425, 96426 and four 96427	...	...	...	...	...	...	...
96425	2050	Clamping Bracket for 96417, 96423 and 96424	...	...	...	...	...	...	...
96426	2050	" " " 96418 to 96420, 96423 and 96424	...	...	...	...	...	...	...
96844	---	" " " 96421	...	...	...	...	...	...	...
96427	2050	" " Rivet for 96417 to 96420, 96423 and 96424	...	...	...	...	...	...	...
96845	---	" " " 96421	...	...	...	...	...	...	...
SS528j	2055	" " Screw	...	...	...	...	...	...	...
NN95j	2055	" " Nut	...	...	...	...	...	...	...

## HAND ATTACHMENT

No.	Plate								
94050	2284	Body	...	...	...	...	...	...	...
94027	2284	" Bracket	...	...	...	...	...	...	...
183e	2114	" " Screw	...	...	...	...	...	...	...
94028	2114	Crank Handle (wood)	...	...	...	...	...	...	...
94029zb	2114	" " Spindle	...	...	...	...	...	...	...
94030zb	2114	" " " Flange (loose)	...	...	...	...	...	...	...
94069	2114	" Hinge Pin	...	...	...	...	...	...	...
94031za	2284	" Lever	...	...	...	...	...	...	...
94032	2114	" " Lock Pin	...	...	...	...	...	...	...
94033zb	2114	" " " Head	...	...	...	...	...	...	...
55531	2114	" " " Spring	...	...	...	...	...	...	...
94034zb	---	Crank, complete, Nos. 94028, 94029zb, 94030zb and 94031za	...	...	...	...	...	...	...
94046	2114	Driver	...	...	...	...	...	...	...
94070	---	" 94046 with 80028 and 94048	...	...	...	...	...	...	...
94036	2114	" Finger	...	...	...	...	...	...	...
94039	2114	" " Driving Pad (raw-hide)	...	...	...	...	...	...	...
94040	2114	" " " Plate	...	...	...	...	...	...	...
SS567e	2114	" " " and Plate Binding Screw	...	...	...	...	...	...	...
94041	---	" " 94036 with SS567e, 94039 and 94040	...	...	...	...	...	...	...
94044	2114	" " Hinge Pin	...	...	...	...	...	...	...
94037	2114	" " Latch	...	...	...	...	...	...	...
SS565e	2114	" " " Screw Stud	...	...	...	...	...	...	...
94038	2114	" " " Spring	...	...	...	...	...	...	...
94051zb	2284	Gear with 55531, 94032 and 94033zb	...	...	...	...	...	...	...
94016	2284	" Cover	...	...	...	...	...	...	...
399a	2114	" " Screw	...	...	...	...	...	...	...
SS599f	2114	" Screw Stud	...	...	...	...	...	...	...
94048	2114	Pinion	...	...	...	...	...	...	...
80028	2114	" Dowel Pin	...	...	...	...	...	...	...
SS600f	2114	" Screw Stud	...	...	...	...	...	...	...
94052zb	2284	Hand Attachment, complete, Nos. SS565e, SS566e, SS599f, SS600f, 94016, 94027, 94034zb, 94037, 94038, 94041, 94044, 94050, 94051zb, 94069, 94070, two each 183e and 399a	...	...	...	...	...	...	...
SS566e	2114	Hand Attachment Screw	...	...	...	...	...	...	...

## OBSOLETE PARTS

No.	Plate	
45253	...	Rotating Hook Slide ... ..
45335	2044	" " " Spring ... ..
45255	—	<b>Rotating Hook Slide</b> , complete, Nos. 45253, 45335 and two 51282zj

## Numerical List of Parts

No.	Plate	
85c	2055	Presser Bar Lifter Hinge Screw ... ..
NN95j	2055	Embroidery Hoop Clamping Bracket Screw Nut for 96417 to 96421, 96423 and 96424
97c	2055	Tension Releasing Lever Hinge Screw ... ..
138c	2055	Arm Screw ... ..
157j	2055	Feed Lifting Rock Shaft Crank Clamping Screw for 45225 ... ..
158c	2055	Bobbin Winder Bracket Screw for 45269 ... ..
175j	2055	Feed Forked Connection Adjusting Screw for 45222 ... ..
183c	2114	Hand Attachment Body Bracket Screw for 94052zb ... ..
190zb	2055	Bobbin Winder Tripping Arm Screw for 45269 and 193732 ... ..
193zb	2049	Bobbin Winder Tension Bracket Screw ... ..
203c	2055	Rotating Hook Driving Shaft Bevel Gear (back) Cover Screw ... ..
207c	2055	Rotating Hook Driving Shaft Bevel Gear (front) Cover Screw ... ..
207e	2055	Rotating Hook Shaft Bevel Gear Cover Screw ... ..
207f	2055	Rotating Hook Bobbin Case Position Plate Screw ... ..
208al	2055	Feed Dog Screw ... ..
224zb	2054	Motor Cover Screw for 201K2 Machine ... ..
239e	2045	Rotating Hook Bobbin Case Position Plate Loop Guard Screw for 45241 ... ..
246za	2048	Clamp Stop Motion Clamp Stop Screw for 45336 ... ..
248za	2055	Clamp Stop Motion Clamp Stop Screw for 45312 ... ..
256zb	2055	Clamp Stop Motion Clamp Screw for 45313
304c	2055	Feed Lifting Rock Shaft Screw Centre ... ..
304e	2055	Feed Rock Shaft Screw Centre ... ..
315c	2055	Feed Bar Screw Centre ... ..
335r	2055	Slack Thread Regulator and Tension Thread Guide Screw ... ..
335zb	2055	Stitch Indicator Plate Screw ... ..
375c	2055	Feed Connecting Rod Hinge Screw ... ..
399a	2114	Hand Attachment Gear Cover Screw for 94052zb ... ..
440c	2055	Rotating Hook Shaft Flanged Bushing Set Screw ... ..
443c	2055	Arm Shaft (horizontal) Bushing Set Screw for 45202 and 45328 ... ..

No.	Plate	
447c	2055	Armature Shaft Bearing Sleeve (commutator end) Set Screw for 193545 ... ..
447c	2055	Armature Shaft Bearing Sleeve (front end) Set Screw for 193545 ... ..
447c	2055	Tension Stud Set Screw ... ..
447c	2055	Thread Take-up Lever Link Hinge Stud Set Screw ... ..
448c	2055	Arm Shaft (upright) Bushing (lower) Set Screw for 45202 and 45328 ... ..
448c	2055	Arm Shaft (upright) Bushing (upper) Set Screw for 45202 and 45328 ... ..
448c	2055	Rotating Hook Driving Shaft Bushing (back) Set Screw ... ..
453c	2055	Presser Bar Guide Bracket Set Screw for 45237 ... ..
462al	2055	Armature Shaft Pinion Set Screw for 193529
SS528j	2055	Embroidery Hoop Clamping Bracket Screw for 96417 to 96421, 96423 and 96424 ... ..
SS565e	2114	Hand Attachment Driver Finger Latch Screw Stud for 94052zb ... ..
SS566c	2114	Hand Attachment Screw for 94052zb ... ..
SS567e	2114	Hand Attachment Driver Finger Driving Pad and Plate Binding Screw for 94041
SS599f	2114	Hand Attachment Gear Screw Stud for 94052zb ... ..
SS600f	2114	Hand Attachment Pinion Screw Stud for 94052zb ... ..
SS616	2310	Radio Noise Eliminator Fastening Screw for 198768 and 198772 ... ..
624c	2055	Singerlight Lead Tube Clamp Set Screw for 201K2 Machine ... ..
641j	2055	Singerlight Screw for 201K2 Machine ... ..
665zb	2055	Needle Bar Thread Guard Screw for 45353
691za	2055	Throat Plate Screw ... ..
707e	2045	Rotating Hook Bobbin Case Retaining Ring Spring Screw for 45272 ... ..
882e	2054	Brush Tube Insulating Bushing Set Screw for 193545 ... ..
896e	2055	Feed Connecting Rod Cap Screw for 45217
1036c	2055	Thread Take-up Crank Set Screw for 45234
1085e	2055	Feed Forked Connection Slide Block Screw Stud for 125335 ... ..
1120c	2055	Rotating Hook Shaft Bevel Gear Set Screw for 45349 ... ..
1130e	2055	Needle Bar Connecting Link Cap Screw for 45233 ... ..
1133c	2055	Needle Bar Bushing Set Screw ... ..

No.	Plate	
1134c	2056	Needle Bar Crank Position Screw for 45234
1172c	2045	Rotating Hook Bobbin Case Tension Regulating Screw for 45276 ... ..
1173d	2045	Rotating Hook Bobbin Case Tension Spring Screw for 45276 ... ..
1259c	2045	Arm Shaft (horizontal) Bevel Gear Set Screw for 45346 ... ..
1259c	2045	Arm Shaft (upright) Bevel Gear (lower) Set Screw for 45347 ... ..
1259c	2045	Arm Shaft (upright) Bevel Gear (upper) Set Screw for 45348 ... ..
1259c	2045	Rotating Hook Driving Shaft Bevel Gear (back) Set Screw for 45853 ... ..
1259c	2045	Rotating Hook Driving Shaft Bevel Gear (front) Set Screw for 45852 ... ..
1299e	2055	Feed Cam and Feed Lifting Eccentric Position Screw for 45322 ... ..
1353c	2045	Needle Bar Connecting Stud Set Screw for 66559 ... ..
1513j	2055	Feed Lifting Rock Shaft Screw Centre Nut
1513j	2055	Feed Rock Shaft Screw Centre Nut ... ..
1518j	2055	Feed Connecting Rod Hinge Screw Nut ... ..
1519j	2055	Feed Bar Screw Centre Nut ... ..
1520j	2055	Feed Forked Connection Hinge Screw Nut ... ..
1550j	2058	Feed Reversing Handle Nut for 125381 ... ..
1768r	2056	Three-Pin Terminal (female half) Housing Screw Nut for 192989 ... ..
1813	2055	Feed Throw-out Lever Roller and Stud for 45220 ... ..
2007	2050	Arm Spool Pin ... ..
2007	2050	Bobbin Winder Spool Pin ... ..
2020	2050	Clamp Stop Motion Clamp Washer for 45312
2070	2050	Presser Bar Spring Washer ... ..
2102	2050	Tension Disc for 45351 ... ..
4389	2050	Arm Dowel Pin (for repairs only) ... ..
7071	2050	Bobbin Winder Tension Bracket Screw Washer ... ..
8217	2050	Feed Regulator Hinge Screw Friction Washer
8366	2041	Presser Bar ... ..
8422	2050	Thread Guard (head of arm) ... ..
8879	2574	Spool Pin Washer (cloth) for 160810 ... ..
12329	2047	Tension Releasing Lever Spring ... ..
15072	2050	Bobbin Winder Bobbin Position Pin for 66671 ... ..
15282	1152	Balance Wheel, 2 1/4" pulley, for 201K1 and 201K4 Machines ... ..

No.	Plate	
15287	2050	Bobbin Winder Friction Ring (rubber) for 45269 and 201K2 Machine ... ..
15288	2050	Bobbin Winder Pulley for 45297 ... ..
*15404	--	Trade Mark for 45202 and 45328 ... ..
15405	--	Trade Mark Rivet for 45202 and 45328 ... ..
21360	2047	Needle Bar Hole Plug ... ..
25525	2575	Bias Gauge ... ..
25527b	2575	Cloth Guide ... ..
25537	2574	Screw Driver (Machine) for 160810 ... ..
25539	2575	Stiletto ... ..
26075	2050	Thread Cutter and Holder ... ..
32503	2047	Arm Shaft (horizontal) Bushing for 45202 and 45328 ... ..
32519	2045	Needle Stop Pin for 45323 ... ..
32522	2047	Rotating Hook Bobbin ... ..
32573	2047	Tension Releasing Lever ... ..
32578	2047	Thread Take-up Crank for 45233 ... ..
32672	1722	Balance Wheel, 3 1/2" pulley, for 201K3 Machine ... ..
32675	2047	Presser Bar Spring ... ..
35931	2574	Hemmer (adjustable) for 160810 ... ..
35932	2575	Quilter ... ..
36583	1956	Tucker ... ..
36865	2574	Edge Stitcher for 160810 ... ..
*45201	--	Arm for 45202 ... ..
45202	--	Arm 45201 with 443c, 15104, 32503, 45207, 45208, two each 448c and 15405, for 201K1, 201K3 and 201K4 Machines ... ..
<i>NOTE: Due to the accuracy required for Gear alignment, Arm cannot be supplied separately and can only be sent out as a unit, Arm and Bed assembled</i>		
45207	2046	Arm Shaft (upright) Bushing (lower) for 45202 and 45328 ... ..
45208	2046	Arm Shaft (upright) Bushing (upper) for 45202 and 45328 ... ..
45209	2044	Arm Top Cover with 45210 ... ..
*45210	--	Arm Top Cover Hub for 45209 ... ..
*45211	--	Bed ... ..
<i>NOTE: Due to the accuracy required for Gear alignment, Bed cannot be supplied separately and can only be sent out as a unit, Arm and Bed assembled.</i>		
*45212	--	Face Plate for 45213 ... ..
45213	2041	Face Plate 45212 with 45214 ... ..
45214	2043	Face Plate Thread Guard 45359 with 125424 for 45213 ... ..

No.	Plate	
45215	2041	Feed Bar ... ..
45217	2042	Feed Connecting Rod with 45218, 125044 and two 896e ... ..
*45218	--	Feed Connecting Rod Cap for 45217 ... ..
45219	2043	Feed Dog (12 teeth, 14 teeth to the inch) for 125319 ... ..
45220	2044	Feed Throw-out Lever with 1813 for 45226 ... ..
45221	2043	Feed Throw-out Lever Thumb Screw Retaining Ring for 45226 ... ..
45222	2042	Feed Forked Connection with 175j for 45291 ... ..
45223	2042	Feed Lifting Rock Shaft for 45224 ... ..
45224	--	Feed Lifting Rock, complete, complete, Nos. 45223 and 45226 ... ..
45225	2044	Feed Lifting Rock Shaft Crank with 157j for 45226 ... ..
45226	--	Feed Lifting Rock Shaft Crank 45225 with 45220, 45221, 50061j and 51294j for 45224 ... ..
45229	2042	Feed Rock Shaft ... ..
*45231	--	Needle Bar Connecting Link with 51002e for 45232 ... ..
45232	2043	Needle Bar Connecting Link 45231 with 66559 for 45233 ... ..
45233	--	Needle Bar Connecting Link 45232 with 1130e and 32578 for 45263 ... ..
45234	2046	Needle Bar Crank with 1036c and 1134c ... ..
45237	2043	Presser Bar Guide Bracket with 443c ... ..
45241	--	Rotating Hook Bobbin Case Position Plate 45292 with 45293 and two 239e ... ..
45242	2041	Rotating Hook Driving Shaft ... ..
45244	2042	Rotating Hook Driving Shaft Bevel Gear (back) Cover, complete, Nos. 45286 and 45287 ... ..
45246	2042	Rotating Hook Driving Shaft Bevel Gear (front) Cover ... ..
45247	2046	Rotating Hook Driving Shaft Bushing (back) ... ..
45249	2043	Rotating Hook Shaft with 45282 ... ..
45251	2042	Rotating Hook Shaft Bevel Gear Cover ... ..
45252	2046	Rotating Hook Shaft Flanged Bushing ... ..
45253	--	Rotating Hook Slide for 45255 (Obsolete) ... ..
45255	--	Rotating Hook Slide, complete, Nos. 45253, 45335 and two 51282zj (Obsolete) ... ..
45261	2044	Thread Take-up Lever for 45262 ... ..
45262	--	Thread Take-up Lever, complete, Nos. 45261, 45264 and 45265 for 45263 ... ..
45263	--	Thread Take-up Lever 45262 with 45233 and 66593 ... ..

 From the library of: [www.needle.com](http://www.needle.com)

No.	Plate	
45264	2044	Thread Take-up Lever Hinge Stud for 45262
45265	2044	Thread Take-up Lever Link for 45262 ...
45268	2049	Bobbin Winder Stop Latch for 45269 and 193732 ...
45269	2049	Bobbin Winder, complete, Nos. 190zb, 15287, 45268, 45297, 51303zb, 51319zb, 66601, 125324, 125326 and 125462 for 201K1, 201K3 and 201K4 Machines ...
*45270	2045	Rotating Hook for 45271 ...
45271	---	Rotating Hook 45270 with 45281 and two 51306e for 45272 ...
45272	---	Rotating Hook 45271 with two each 707e and 45279 for 45273 ...
45273	2045	Rotating Hook, complete, Nos. 45272 and 45278 for 45274 ...
45274	---	Rotating Hook and Bobbin Case, complete, Nos. 45273 and 45276 ...
*45275	---	Rotating Hook Bobbin Case for 45276 ...
45276	2045	Rotating Hook Bobbin Case, complete, Nos. 1172c, 1173d, 45275, 45277, 45280 and 51302e for 45274 ...
45277	2045	Rotating Hook Bobbin Case Finger for 45276
45278	2045	Rotating Hook Bobbin Case Retaining Ring for 45273 ...
45279	2045	Rotating Hook Bobbin Case Retaining Ring Spring for 45272 ...
45280	2045	Rotating Hook Bobbin Case Tension Spring for 45276 ...
45281	2045	Rotating Hook Needle Guard for 45271 ...
45282	2045	Rotating Hook Position Pin for 45249 ...
45285	2047	Needle Clamp 45334 with 51308a1 ...
*45286	---	Rotating Hook Driving Shaft Bevel Gear (back) Cover Body for 45244 ...
*45287	---	Rotating Hook Driving Shaft Bevel Gear (back) Cover Body End Cap for 45244 ...
*45289	---	Stitch Regulating Thumb Screw Bushing for 45308 ...
45291	---	Feed Forked Connection 45222 with 125335
45292	2045	Rotating Hook Bobbin Case Position Plate for 45241 ...
45293	2045	Rotating Hook Bobbin Case Position Plate Loop Guard for 45241 ...
45294	2048	Clamp Stop Motion Flanged Bushing for 45295
45295	---	Clamp Stop Motion Flanged Bushing 45294 with 51280zb for 45336 ...
45297	---	Bobbin Winder Frame 66670 with 15288 and 66671, for 45269 and 193732 ...

No.	Plate	
45299	2042	Arm Shaft (horizontal) ...
45305	2058	Feed Reversing Handle for 125381 ...
45306	2058	Stitch Indicator Plate for 45309 ...
45307	---	Stitch Regulating Plate for 45308 ...
45308	2058	Stitch Regulating Plate 45307 with 45289 for 45309 ...
45309	---	Stitch Regulating Plate 45308 with 45306, 45310, 51312zb and 125400 ...
45310	2058	Stitch Regulating Thumb Screw Washer (fibre) for 45309 ...
45311	2046	Clamp Stop Motion Flanged Bushing for 45313 ...
45312	---	Clamp Stop Motion, complete, Nos. 248za, 2020, 45313 and 51320c, for 201K1, 201K3 and 201K4 Machines ...
45313	---	Clamp Stop Motion Flanged Bushing 45311 with 256zb for 45312 ...
45319	---	Presser Foot Plate for 45321 ...
*45320	---	Presser Foot Shank for 45321 ...
45321	2047	Presser Foot (hinged), complete, Nos. 45319, 45320 and 45329 ...
45322	2046	Feed Cam and Feed Lifting Eccentric (counterbalanced) with 1299c ...
45323	2043	Needle Bar with 32519 and 45324 ...
*45324	2048	Needle Bar Plug for 45323 ...
45325	2046	Feed Regulator for 45326 ...
45326	---	Feed Regulator 45325 with 125381 ...
*45327	---	Arm for 45328 ...
45328	---	Arm 45327 with 443c, 15404, 32503, 45207, 45208, two each 448c and 15405 for 201K2 Machine ...
NOTE. Due to the accuracy required for Gear alignment, Arm cannot be supplied separately and can only be sent out as a unit, Arm and Bed assembled.		
45329	---	Presser Foot Hinge Pin for 45321 ...
45334	---	Needle Clamp with 140545zc, for 45285 ...
45335	2044	Rotating Hook Slide Spring for 45255 (Obsolete)
45336	---	Clamp Stop Motion, complete, Nos. 246za, 45295, 51320c and 125359 for 201K2 Machine ...
45339	2392	Tension Regulating Thumb Nut Engaging Pin for 51682zb ...
45341	2392	Tension Releasing Pin for 45351 ...
45343	2043	Thread Take-up Spring Thread Guard for 45351 ...

From the library of: Diamond Needle Co.

No.	Plate	
45345	2044	Slack Thread Regulator and Tension Thread Guide ... ..
45346	2044	Arm Shaft (horizontal) Bevel Gear (right hand spiral) with two 1259c ... ..
45347	2044	Arm Shaft (upright) Bevel Gear (lower, right hand spiral) with two 1259c ... ..
45348	2044	Arm Shaft (upright) Bevel Gear (upper, left hand spiral) with two 1259c ... ..
45349	2044	Rotating Hook Shaft Bevel Gear (left hand spiral) with two 1120c ... ..
45350	---	Drip Pan with four wood screws $\frac{1}{2}$ " No. 5 ... ..
45351	---	Tension (graduated), complete, Nos. 45341, 45343, 45352, 45865, 66774, 125314, 125416, 125421 and two 2102 ... ..
45352	---	Tension Stud 140178zb with 51682zb, for 45351 ... ..
45353	---	Needle Bar Bushing 66558 with 665zb and 45354 ... ..
45354	2044	Needle Bar Thread Guard for 45353 ... ..
45355	2044	Needle Clamp Gib and Thread Guard ... ..
45356	2043	Rotating Hook Slide for 45358 ... ..
45357	2043	Rotating Hook Slide Spring for 45358 ... ..
45358	---	Rotating Hook Slide, complete, Nos. 45356, 45357 and two 51282zj ... ..
45359	2043	Face Plate Thread Guard for 45214 ... ..
45360	2392	Rotating Hook Driving Shaft Bushing (front) ... ..
45845	2392	Bobbin Winder Tension Disc for 125396 ... ..
45846	2392	Bobbin Winder Tension Disc Spring Disc for 125396 ... ..
45847	2392	Bobbin Winder Tension Disc Spring for 125396 ... ..
45852	2044	Rotating Hook Driving Shaft Bevel Gear (front, right hand spiral) with two 1259c ... ..
45853	2044	Rotating Hook Driving Shaft Bevel Gear (back, left hand spiral) with two 1259c ... ..
45865	2392	Tension Indicator Flange Stop Washer for 45351 ... ..

No.	Plate	
50053b	2575	Cloth Guide and Under Braider Thumb Screw ... ..
50061j	2055	Feed Throw-out Lever Hinge Screw for 45226 ... ..
50150c	2045	Rotating Hook Driving Shaft Collar Screw for 66581 ... ..
50463f	2045	Rotating Hook Screw ... ..
50617zb	2056	Armature Shaft Bearing Sleeve (front end) Cap Screw for 201K2 Machine ... ..
50657r	2054	Three-Pin Terminal (male half) Screw for 201K2 Machine ... ..
50684zb	2056	Face Plate Thumb Screw ... ..
50996zb	2056	Face Plate Screw ... ..
51002e	2055	Needle Bar Connecting Link Adjusting Screw for 45231 ... ..
51045c	2055	Machine Hinge Connection Set Screw ... ..
51093r	2056	Three-Pin Terminal (female half) Housing Screw for 192989 ... ..
51224zb	2055	Arm Side Cover Thumb Screw ... ..
51224zb	2055	Presser Foot Thumb Screw ... ..
*51228zb	2055	Pressure Regulating Thumb Screw for 66773 ... ..
51252c	2055	Feed Forked Connection Hinge Screw (eccentric) ... ..
51280zb	2048	Clamp Stop Motion Clamp Screw for 45295 ... ..
51281c	2056	Balance Wheel Gear Collar Set Screw for 125353 ... ..
51282zj	2044	Rotating Hook Slide Spring Screw for 45255 and 45358 ... ..
51284r	2054	Grease Wick Spring Cap Screw for 201K2 Machine ... ..
51285e	2054	Motor Frame Screw for 201K2 Machine ... ..
51286r	2054	Field Core Screw for 201K2 Machine ... ..
51293c	2054	Three-Pin Terminal (male half) Bracket Screw for 201K2 Machine ... ..
51294x	2056	Feed Throw-out Lever Thumb Screw for 45226 ... ..
51295e	2056	Feed Regulator Hinge Screw ... ..
51302e	2045	Rotating Hook Bobbin Case Finger Screw for 45276 ... ..
51303zb	2055	Bobbin Winder Stop Latch Hinge Screw for 45269 and 193732 ... ..
51306e	2045	Rotating Hook Needle Guard Screw for 45271 ... ..
51308af	2055	Needle Clamp Position Screw for 45285 ... ..
51312zb	2058	Stitch Regulating Thumb Screw for 45309 ... ..
51319zb	2056	Bobbin Winder Frame Hinge Screw for 45269 and 193732 ... ..

No.	Plate	
51320c	2056	Clamp Stop Motion Flanged Bushing Set Screw for 45312 and 45336 ... ..
51367zb	2056	Singerlight Lamp Socket Screw for 193930
51399e	2056	Singerlight Lamp Socket Cap Screw for 194050 ... ..
51401e	2056	Singerlight Lead Tube Clamping Screw for 193931 ... ..
51582	2056	Three-Pin Terminal (male half) Post Thumb Nut for 193935 ... ..
51623	2056	Singerlight Toggle Switch Lock Nut for 194274 ... ..
51682zb	2392	Tension Regulating Thumb Nut with 45339, for 45352 ... ..
55531	2114	Hand Attachment Crank Lever Lock Pin Spring for 94051zb ... ..



No.	Plate	
66558	2050	Needle Bar Bushing for 45353 ... ..
66559	2047	Needle Bar Connecting Stud with 45232, for 45232 ... ..
66561	2047	Needle Bar Timing Gauge ... ..
66564	2017	Presser Bar Lifter ... ..
66581	2043	Rotating Hook Driving Shaft Collar with two 50150c ... ..
66593	2044	Thread Take-up Lever Link Hinge Stud for 45263 ... ..
66601	2050	Bobbin Winder Frame Spring for 45269 ... ..
66643	2042	Arm Shaft (upright) ... ..
66670	2050	Bobbin Winder Frame for 45297 ... ..
66671	2049	Bobbin Winder Spindle with 15072 for 45297
66752	2050	Pressure Regulating Thumb Screw Plug (felt wick) for 66773 ... ..
66773	—	Pressure Regulating Thumb Screw 51228zb with 66752 ... ..
66774	2043	Thread Take-up Spring for 45351 ... ..

81108 THREAD TAKE-UP LEVER LINK HINGE STUD FOR 81111

81111 THREAD TAKE-UP LEVER 45263 WITH 45232 AND 45233 AND 81108 FOR 206K21, 206K23 AND 206K24 M/Cs FORMERLY SER N37196

No.	Plate	
80028	2114	Hand Attachment Pinion Dowel Pin for 94070 ... ..
85893	1956	Embroidery Foot (for art work) ... ..
86642	2574	Ruffler for 160810 ... ..
87586		Embroidery Hoop (round, birch) 5 $\frac{5}{8}$ " diam. $\times$ 7 $\frac{7}{16}$ " high ... ..
87589	1221	Embroidery Hoop (round, birch) 8" diam. $\times$ 7 $\frac{7}{16}$ " high ... ..
87593		Embroidery Hoop (round, birch) 10" diam. $\times$ 7 $\frac{7}{16}$ " high ... ..
87595		Embroidery Hoop (round, birch) 12" diam. $\times$ 1" high ... ..
87597		Embroidery Hoop (oval, birch) 12" $\times$ 5 $\frac{1}{2}$ " $\times$ 7 $\frac{7}{16}$ " high ... ..
94016	2284	Hand Attachment Gear Cover for 94052zb
94027	2284	Hand Attachment Body Bracket for 94052zb
94028	2114	Hand Attachment Crank Handle (wood) for 94034zb ... ..
94029zb	2114	Hand Attachment Crank Handle Spindle for 94034zb ... ..
94030zb	2114	Hand Attachment Crank Handle Spindle Flange (loose) for 94034zb ... ..
94031za	2284	Hand Attachment Crank Lever for 94034zb
94032	2114	Hand Attachment Crank Lever Lock Pin for 94051zb ... ..
94033zb	2114	Hand Attachment Crank Lever Lock Pin Head for 94051zb ... ..
94034zb		Hand Attachment Crank, complete, Nos. 94028, 94029zb, 94030zb and 94031za, for 94052zb ... ..
94036	2114	Hand Attachment Driver Finger for 94041
94037	2114	Hand Attachment Driver Finger Latch for 94052zb ... ..
94038	2114	Hand Attachment Driver Finger Latch Spring for 94052zb ... ..
94039	2114	Hand Attachment Driver Finger Driving Pad (raw-hide) for 94041 ... ..
94040	2114	Hand Attachment Driver Finger Driving Pad Plate for 94041 ... ..
94041		Hand Attachment Driver Finger 94036 with SS567c, 94039 and 94040 for 94052zb
94044	2114	Hand Attachment Driver Finger Hinge Pin for 94052zb ... ..
94046	2114	Hand Attachment Driver for 94070 ... ..
94048	2114	Hand Attachment Pinion for 94070 ... ..
94050	2284	Hand Attachment Body for 94052zb ... ..

Point the library of Hamilton Needle Corp.

No.	Plate	
94051zb	2284	Hand Attachment Gear, with 55531, 94032 and 94033zb, for 94052zb ... ..
94052zb	2284	Hand Attachment, complete, Nos. SS565e, SS566e, SS599f, SS600f, 94016, 94027, 94034zb, 94037, 94038, 94041, 94044, 94050, 94051zb, 94069, 94070, two each 183e and 399a ... ..
94069	2114	Hand Attachment Crank Hinge Pin for 94052zb ... ..
94070	—	Hand Attachment Driver 94046 with 80028 and 94048, for 94052zb ... ..
96416	—	Embroidery Hoop (round, birch) 7" diam. $\times$ $7\frac{m}{m}$ high ... ..
96417	---	Embroidery Hoop (round, birch) $5\frac{5}{8}$ " diam. $\times$ $7\frac{m}{m}$ high, with SS528j, NN95j, two 96425 and four 96427 ... ..
96418	---	Embroidery Hoop (round, birch) 7" diam. $\times$ $7\frac{m}{m}$ high with SS528j, NN95j, two 96426 and four 96427 ... ..
96419	---	Embroidery Hoop (round, birch) 8" diam. $\times$ $7\frac{m}{m}$ high, with SS528j, NN95j, two 96426 and four 96427 ... ..
96420	---	Embroidery Hoop (round, birch) 10" diam. $\times$ $7\frac{1}{8}$ " high with SS528j, NN95j, two 96426, and four 96427 ... ..
96421	---	Embroidery Hoop (round, birch) 12" diam. $\times$ $\frac{1}{2}$ " high, with SS528j, NN95j, two 96844 and four 96845 ... ..
96422	1221	Embroidery Hoop (oval, birch) 9" $\times$ $4\frac{1}{2}$ " $\times$ $7\frac{m}{m}$ high ... ..
96423	---	Embroidery Hoop (oval, birch) 9" $\times$ $4\frac{1}{2}$ " $\times$ $7\frac{m}{m}$ high, with SS528j, NN95j, 96425, 96426 and four 96427 ... ..
96424	---	Embroidery Hoop (oval, birch) 12" $\times$ $5\frac{1}{2}$ " $\times$ $7\frac{m}{m}$ high, with SS528j, NN95j, 96425, 96426 and four 96427 ... ..
96425	2050	Embroidery Hoop Clamping Bracket for 96417, 96423 and 96424 ... ..
96426	2050	Embroidery Hoop Clamping Bracket for 96418 to 96420, 96423 and 96424 ... ..
96427	2050	Embroidery Hoop Clamping Bracket Rivet for 96417 to 96420, 96423 and 96424 ... ..
96844	---	Embroidery Hoop Clamping Bracket for 96421 ... ..
96845	---	Embroidery Hoop Clamping Bracket Rivet for 96421 ... ..

No.	Plate	
97382	2053	Bayonet Plug, complete, Nos. 97383 and 97384 ... ..
97383	2053	Bayonet Plug Body for 97382 ... ..
97384	2053	Bayonet Plug Cover for 97382 ... ..

No.	Plate	
120290	930	Ruffler ... ..
120378	2574	Screw Driver (Bobbin Case) for 160810 ...
120687	1956	Imitation Hemstitching Attachment with Yielding Presser Plate ... ..
120855	2575	Hemmer (foot), $\frac{5}{8}$ " hem ... ..
120861	---	Tin of Oil (3 oz.) ... ..
120914	2575	Feller (foot) ... ..
121094	2575	Spring Darning Foot ... ..
121170	909	Ruffler Shirring Plate ... ..
121441	2574	Gathering Foot (double toe) for 160810 ...
121464	2574	Binder for 160810 ... ..
121547	909	Under Braider ... ..
121875	---	Presser Foot for 121877 ... ..
121876	---	Presser Foot Body for 121877 ... ..
121877	2575	Presser Foot (adjustable for sewing on the right or left side of the needle), complete, Nos. 121875, 121876 and 140347w for Cording and Slide Fastener Work ...
125035	2575	Presser Foot (for sewing on left side of needle) for Stitching on Edge and Insert- ing Cord ... ..
125044	2050	Feed Connecting Rod Oil Pad (felt) for 45217
125047	2047	Feed Forked Connection Slide Block for 125335 ... ..
125314	2047	Tension Spring for 45351 ... ..
125319	2047	Throat Plate for 45219 ... ..
†125324	2049	Bobbin Winder Bracket (belt cover) for 45269 ... ..
125326	2050	Bobbin Winder Tripping Arm for 45269 and 193732 ... ..
125331	2050	Arm Oil Pad (felt) for oiling Arm Shaft (horizontal) Back Bearing ... ..
125333	2050	Arm Oil Pad Spring ... ..
125334	2050	Arm Oil Pad Spring Cap ... ..
125335	---	Feed Forked Connection Slide Block 125047 with 1085e, for 45291 ... ..
125350zb	2052	Balance Wheel with 125358 for 125364 ...
125351	2048	Balance Wheel Gear (textolite) for 125352 ...
125352	2048	Balance Wheel Gear 125351 with 125356 and 125357 for 125364 ... ..
125353	2048	Balance Wheel Gear Collar with three 51281c for 125364 ... ..
125354	2048	Balance Wheel Gear Spring for 125364 ...
125355	2048	Balance Wheel Gear Spring Retaining Washer for 125364 ... ..

† In ordering it is necessary to state class of machine.

No.	Plate	
125356	2048	Balance Wheel Gear Spring Stud for 125352
125357	---	Balance Wheel Gear Spring Stud Washer for 125352 ... ..
125358	2048	Balance Wheel Spring Stud for 125350zb ...
125359	2048	Clamp Stop Motion Clamp Washer for 45336
125364	---	Balance Wheel 125350 with 125352 to 125355 and two 125385 for 201K2 Machine ...
125365	2049	Bobbin Winder Frame Spring for 193732 ...
125381	---	Feed Reversing Handle 45305 with 1550j for 45326 ... ..
125385	2048	Balance Wheel Gear Spring Cushion Pin (eccentric) for 125364 ... ..
125395	2392	Bobbin Winder Tension Bracket for 125396
125396	---	Bobbin Winder Tension Bracket, complete, Nos. 45845 to 45847, 125395 and 140138b
125400	2044	Stitch Regulating Thumb Screw Friction Washer for 45309 ... ..
125416	2392	Tension Indicator Flange for 45351 ... ..
125421	2392	Tension Indicator for 45351 ... ..
125424	2043	Face Plate Thread Guard Rivet for 45214 ...
125425	2392	Arm Side Cover ... ..
125462	2050	Bobbin Winder Stop Latch Spring for 45269 and 193732 ... ..

No.	Plate	
140138b	2392	Bobbin Winder Tension Screw for 125396 ...
*140178zb	2392	Tension Stud for 45352 ... ..
140238c	2392	Rotating Hook Driving Shaft Bushing (front) Set Screw ... ..
140347w	2575	Presser Foot Adjusting Thumb Screw for 121877 ... ..
140545zc	2055	Needle Clamp Thumb Screw for 45334 ...

No.	Plate	
190439		Tube, filled with Lubricant for Singer Electric Motors, for 190613 ... ..
190612		Tube Carton (paper) for 190613 ... ..
190613		Tube 190439 with 190612, for P.H.K. Motors, for 201K2 Machine ... ..
191980		Singerlight Lamp Socket Terminal Plunger Housing for 193915 ... ..
191981		Singerlight Lamp Socket Terminal Plunger for 193915 ... ..
191982		Singerlight Lamp Socket Terminal Plunger Spring for 193915 ... ..
192421	2054	Field Coil Retainer for 201K2 Machine ...
192457	2054	Brush (carbon) for 50 to 145 volts for 201K2 Machine ... ..
192458	2054	Brush Spring for 201K2 Machine ... ..
*192643		Three-Pin Terminal (female half) Housing (upper) for 192989 ... ..
*192644		Three-Pin Terminal (female half) Housing (lower) for 192989 ... ..
192691	2054	Three-Pin Terminal (female half) Insert Sleeve for 192989 ... ..
192692	2054	Three-Pin Terminal (female half) Insert Clamp for 192989 ... ..
192790	2054	Three-Pin Terminal Adaptor Bushing for 192851 ... ..
192793	2054	Three-Pin Terminal (male half) Post for 193934 ... ..
192851	2052	Lead Cord, complete, from Lamp Socket to Three-Pin Terminal, Nos. 192790, 192852, 192989 and Plug, for Knee and Treadle Control for 201K2 Machine ... ..
*192852	2052	Lead Cord for 192851 ... ..
192989	2052	Three-Pin Terminal (female half), complete, Nos. 192643, 192644, two each 1768r, 51093r, three each 192691 and 192692 for 192851 ... ..
†193522	2053	Motor Frame for 193545 ... ..
193523	2054	Armature Shaft Bearing Sleeve (commutator end) for 193545 ... ..
193524	2054	Armature Shaft Bearing Sleeve (front end) for 193545 ... ..
193525		Grease Wick 193526 with 193527 for 201K2 Machine ... ..
193526	2054	Grease Wick for 193525 ... ..
193527	2054	Grease Wick Spring for 193525 ... ..

‡ In ordering it is necessary to state class of machine

No.	Plate	
*193528	---	Armature Shaft for 201K2 Machine ...
193529	2054	Armature Shaft Pinion (spiral), with two 462al for 201K2 Machine ...
193536	2052	Commutator, complete, for 201K2 Machine
*193540	---	Armature Core, complete, for 201K2 Machine
193541	2052	Field Core, complete, for 201K2 Machine ...
193542	2054	Armature Shaft Oil Sling for 201K2 Machine
193543	2054	Brush Cap for 201K2 Machine ...
†193544	2052	Motor Cover for 201K2 Machine ...
†193545	2053	Motor Frame 193522 with 193523, 193524, two each 447c and 882e for 193732 ...
193546	2054	Brush Tube Insulating Bushing for 201K2 Machine ...

**Nos. 193555 to 193600 are for 201K2 Machine.**

193555	---	Armature, complete, for P.H.K.3 Motor ...
193556	---	Armature, complete, for P.H.K.5 Motor ...
193557	---	Armature, complete, for P.H.K.6 and P.H.K.7 Motors ...
193558	---	Armature, complete, for P.H.K.8 Motor ...
193559	---	Armature, complete, for P.H.K.9 Motor ...
193560	---	Armature, complete, for P.H.K.10 and P.H.K.92 Motors ...
193561	2052	Armature, complete, for P.H.K.11 and P.H.K.12 Motors ...
193562	---	Armature, complete, for P.H.K.15 Motor ...
193563	---	Armature, complete, for P.H.K.87 Motor ...
193564	---	Armature, complete, for P.H.K.90 Motor ...
193565	---	Field Coil, complete, for P.H.K.3 Motor ...
193568	---	Field Coil, complete, for P.H.K.5 Motor ...
193571	---	Field Coil, complete, for P.H.K.6 Motor ...
193574	---	Field Coil, complete, for P.H.K.7 Motor ...
193577	---	Field Coil, complete, for P.H.K.8 Motor ...
193580	---	Field Coil, complete, for P.H.K.9 Motor ...
193583	---	Field Coil, complete, for P.H.K.10 and P.H.K.11 Motors ...
193586	---	Field Coil, complete, for P.H.K.12 Motor ...
193589	---	Field Coil, complete, for P.H.K.15 Motor ...
193592	---	Field Coil, complete, for P.H.K.87 Motor ...
193595	---	Field Coil, complete, for P.H.K.90 Motor ...
193598	---	Field Coil, complete, for P.H.K.92 Motor ...
193640	2054	Grease Wick Spring Retainer for 201K2 Machine ...

*† In ordering it is necessary to state class of machine*

No.	Plate	
*193732	---	Motor Frame 193545 with 190zb, 45268 45297, 51303zb, 51319zb, 125326, 125365 and 125462 for 201K2 Machine ...
193799	---	Brush (carbon) for 150 to 250 volts for 201K2 Machine ...
193892	2053	Singerlight Toggle Switch Lead, complete, Nos. 193893 and 195834, for 194274 ...
*193893	---	Singerlight Toggle Switch Lead for 193892 ...
193911	2053	Singerlight Lamp Socket for 194050 ...
193912	2053	Singerlight Lamp Socket Cap with 193913 for 194050 ...
*193913	---	Singerlight Lamp Socket Cap Insert for 193912 ...
193914	---	Singerlight Lamp Socket Terminal Lug for 193915 ...
193915	---	Singerlight Lamp Socket Terminal, complete, Nos. 191980 to 191982 and 193914, for 194050 ...
193919	2054	Singerlight Toggle Switch Thumb Nut (moulded) for 194273 ...
193930	---	Singerlight (less lamp and switch), complete, Nos. 51367zb, 193931, 194050, 194085 and 701994, for 201K2 Machine ...
193931	2052	Singerlight Shade and Lamp Socket Housing with 51401e for 193930 ...
*193933	---	Three-Pin Terminal (male half) and Singerlight Switch Compartment for 193934 ...
*193934	---	Three-Pin Terminal (male half) and Singerlight Switch Compartment 193933 with three 192793 for 193935 ...
193935	2053	Three-Pin Terminal (male half) and Singerlight Switch Compartment, complete, Nos. 193934, three each 51582 and 701719 for 201K2 Machine ...
194050	2053	Singerlight Lamp Socket 193911 with 193912, 194083, two each 51399e and 193915, for 193930 ...
194073	2053	Singerlight Lead (yellow tracer thread), complete, Nos. 194074 and 195834, for 194083 ...
*194074	---	Singerlight Lead (yellow tracer thread) for 194073 ...
194075	2053	Singerlight Lead Tube, 10 $\frac{1}{2}$ " long (wire mould) for 194083 ...
194082	2053	Singerlight Lead Tube Clamp for 201K2 Machine

No.	Plate	
194083	—	Singerlight Lead, complete, Nos. 194073, 194075 and 194084 for 194050 ...
194084	2053	Singerlight Lead (white) for 194083 ...
194085	—	Singerlight Lead Tube Clamping Plate (fibre) for 193930 ...
194093	2052	Three-Pin Terminal (male half) Bracket for 201K2 Machine ...
194113	2054	Brush Tube for 201K2 Machine ...
194120	—	Singerlight Lamp ...
<i>NOTE.—When ordering state voltage required.</i>		
*194273	2053	Singerlight Toggle Switch with 193919, for 194274 ...
194274	2053	Singerlight Toggle Switch with Lead, complete, Nos. 51623, 193892 and 194273, for 201K2 Machine ...
194591		Brush (carbon) for 25 and 32 volts ...
195834		Field Coil Lead Terminal Clip for 201K2 Machine ...
195834		Singerlight Lead Terminal Clip for 194073 ...
195834		Singerlight Toggle Switch Lead Terminal Clip for 193892 ...

No.	Plate	
198052	2052	Two-Pin Plug ...
198108	—	Two-Pin Plug (Norwegian) ...
198138	—	Two-Pin Plug (Danish) ...
198367	—	Two-Pin Plug (Swiss) ...
198768	—	Radio Noise Eliminator, complete, No. 198771 and two SS616, for 201K2 Machine
198769	—	Radio Noise Eliminator .1 + .1 Microfarads, with two fuses, Nos. 198775 and 198778, for 198771 ...
198771	2310	Radio Noise Eliminator 198769, with 194525, 194526, 198770 and three 198414, for 198768 ...
198772	—	Radio Noise Eliminator, complete, No. 198773 and two SS616, for 201K2 Machine when grounded ...
198773	2310	Radio Noise Eliminator 198779, with 194525, 194526, 198774 and three 198414, for 198772 ...
198779	—	Radio Noise Eliminator .1 + .1 + .005 Microfarads, with two fuses, Nos. 198776 and 198778, for 198773 ...

No.	Plate	
701719	2054	Three-Pin Terminal (male half) Post Washer for 193935 ... ..
701994	2053	Singerlight Lamp Socket Screw Insulating Washer for 193930 ... ..
727511	2054	Field Coil Lead Bushing (rubber) for 201K2 Machine ... ..
899677	2054	Name Plate for all P.H.K. Motors ...
931275	—	Armature Wire Separator (linen) for 201K2 Machine ... ..